



STIGA®



**Reservdelar & Tillbehör
2011**

KNIVSPETSAR

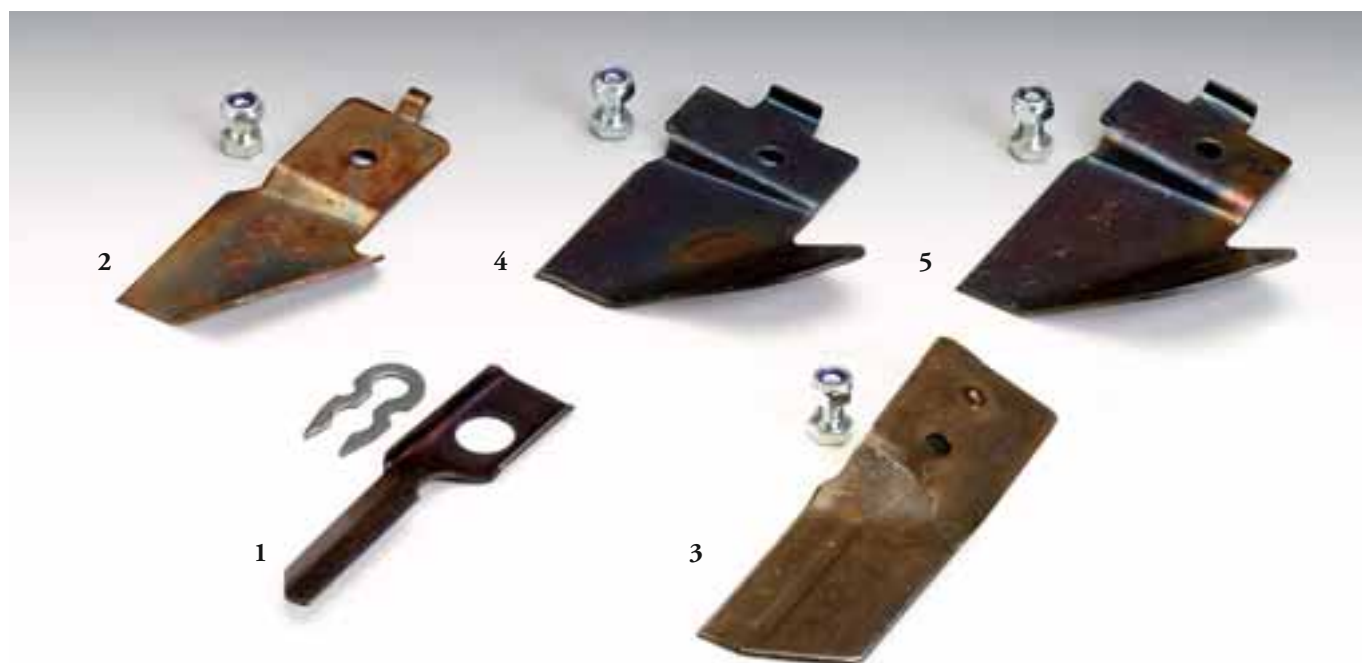

Pos	Detaljnr.	Benämning	Passar till
1	1111-9021-01	Knivsats	Dino, Tornado
2	1111-9046-01	Knivsats	Turbo 35 el, Silent 35 el
3	1111-9049-01	Knivsats	Multiclip, Pro 48
4	1111-9048-01	Knivsats	Turbo 42, Turbo 460, Collector 46, Silent 42 el
5	1111-9050-01	Knivsats	Turbo 510-530

KNIVAR (MULTICLIP)

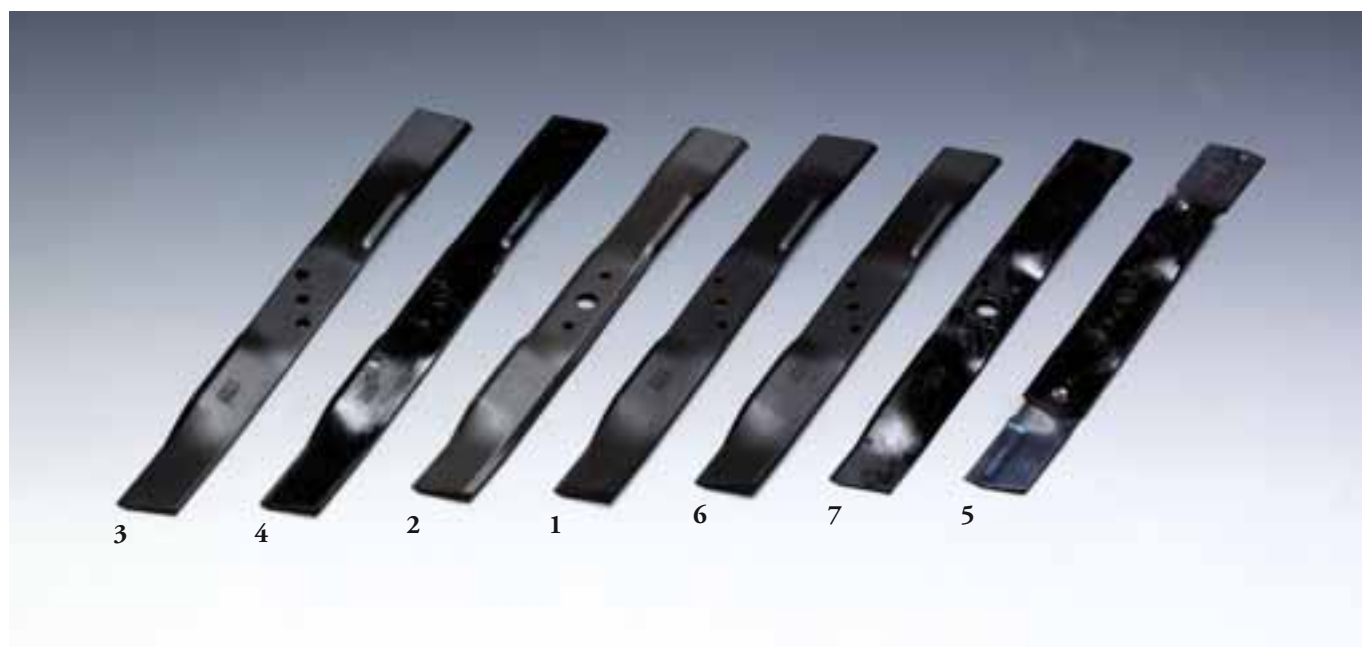

Pos	Detaljnr.	Benämning	Passar till	Innehåller
1	1111-9075-01	Kniv	Multiclip 48-Pro 48	1111-2442-01
2	1111-9155-01	Kniv	Multiclip 50/50 El Svan/50S/50 Plus/ Pro 50, 50 Rental/50S Rental/Pro 50 Svan (2009-)/ Pro 50 4S (2011-)	81004146/0
2	1111-9184-01	Kniv	Multiclip 50S Silent	181004148/0
3	1111-9109-01	Kniv (tapphål 11 mm)	Multiclip 51S/53S-Pro 51S	81004138/0
4	1111-9076-01	Kniv (tapphål 8 mm)	Multiclip 51S-Pro 51S	1111-2442-02
5	1111-9077-01	Knivbalk	Multiclip 46	1111-1603-01
6	1111-9078-01	Kniv	Multiclip 46	1111-3099-01
7	1111-9079-01	Kniv	Multiclip 46 el	1111-3010-01

Anm. Detaljnr. 1111-9184-01 har två extra hål (Ø 6,5 mm) för montering av fläkt.

KNIVAR

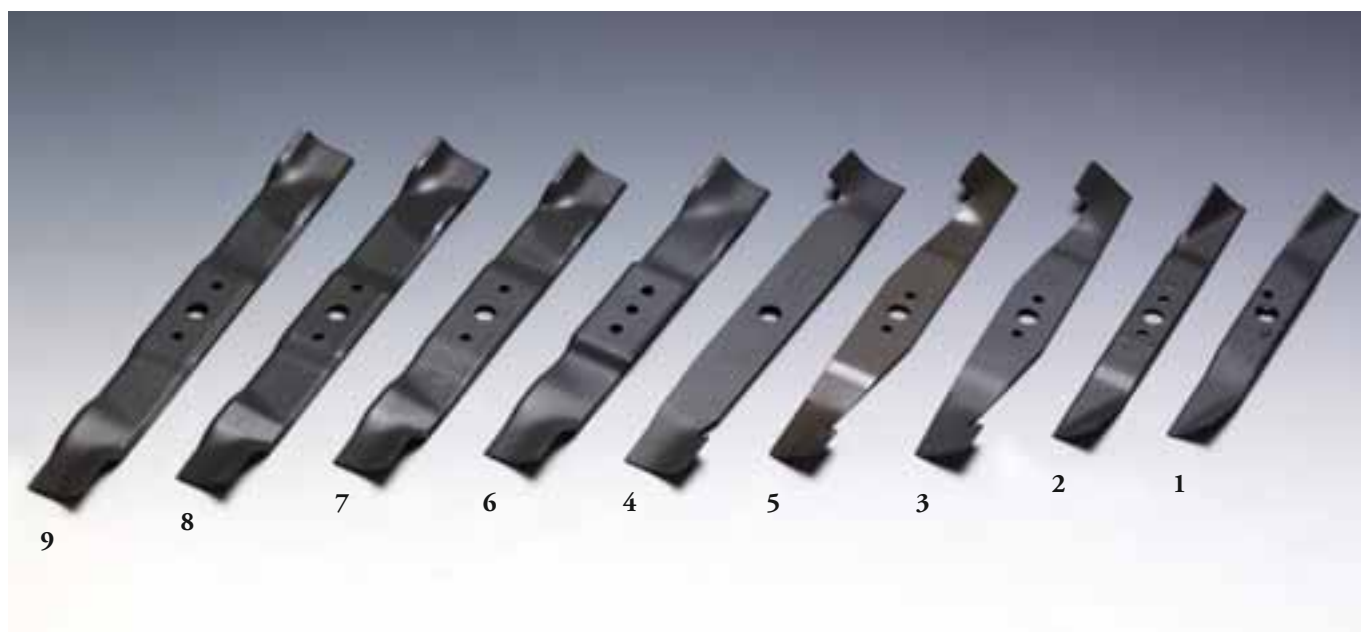

Pos	Detaljnr.	Benämning	Passar till	Innehåller
1	1111-9082-01	Kniv	Euro 33 el, Silent 33 el, Ladybird 33 el	81004127/0
2	1111-9156-01	Kniv	Turbo 35 el, Collector 35 el	81004115/1
3	1111-9157-01	Kniv	Turbo 39 el, Collector 39 el	81004117/1
4	1111-9084-01	Kniv	Silent 41 el (plastic-chassis), Ladybird 42 el	81004119/0
5	1111-9158-01	Kniv	Turbo 41 el	81004145/0
6	1111-9115-01	Kniv	Euro 40, Collector 40	81004122/0
7	1111-9142-01	Kniv	Collector 43	81004341/3
8	1111-9143-01	Kniv	Collector 44/46; Combi 46	81004365/3
9	1111-9121-01	Kniv	Razer, 46S, 46PD, Turbo 47, Collector 46 Roller, Razer 48S, Multimower 48, Collector 48, Turbo 48 S BW Plus (2010-), Turbo 48 Plus (2011-), Combi 48 (2011-)	81004346/3

KNIVAR

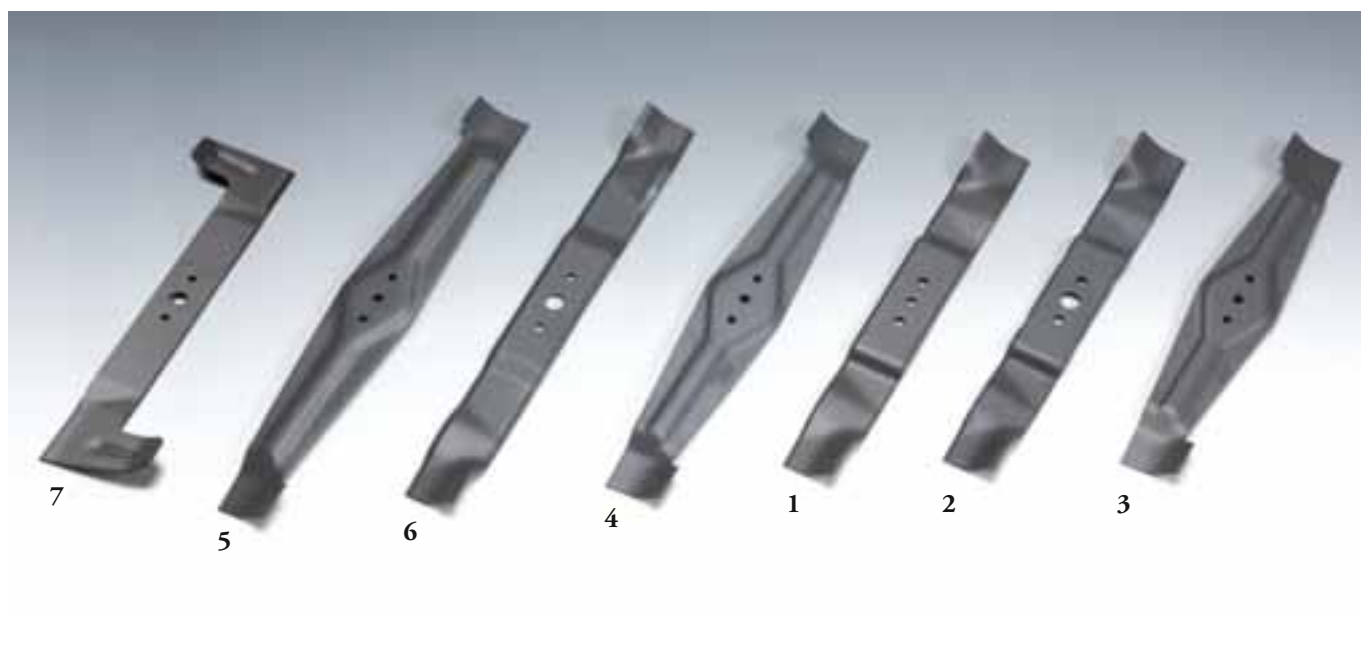

Pos	Detaljnr.	Benämning	Passar till	Innehåller
1	1111-9116-01	Kniv	Combi 45, Collector 45/46, Silent 45, Turbo 45, Euro 45, Collector 45	81004121/0
2	1111-9117-01	Kniv	Silent 45 el, Ladybird 45	81004120/0
3	1111-9089-01	Kniv	Turbo 43/45	81004131/0
4	1111-9090-01	Kniv	Turbo 48/50, Collector 48/50	81004143/0
5	1111-9091-01	Kniv	Turbo 55, Collector 55	81004144/0
6	1111-9122-01	Kniv	Collector 53, Combi 53/53S/53 SQ BW/53 SEQ BW (2010-), Turbo 53S BW Plus B/H (2009-)	81004381/1
6	1111-9187-01	Kniv	Turbo 53S Silent	181004394/0
7	1111-9193-01	Kniv ("winged")	Combi 48S, Turbo 48 S	81004397/0
7	1111-9194-01	Kniv ("winged")	Collector 53S BW, Turbo 53S BW, S Inox	81004398/0

Anm. Detaljnr. 1111-9187-01 har två extra hål (Ø 6,5 mm) för montering av fläkt.

FRIKTIONSKNIVAR

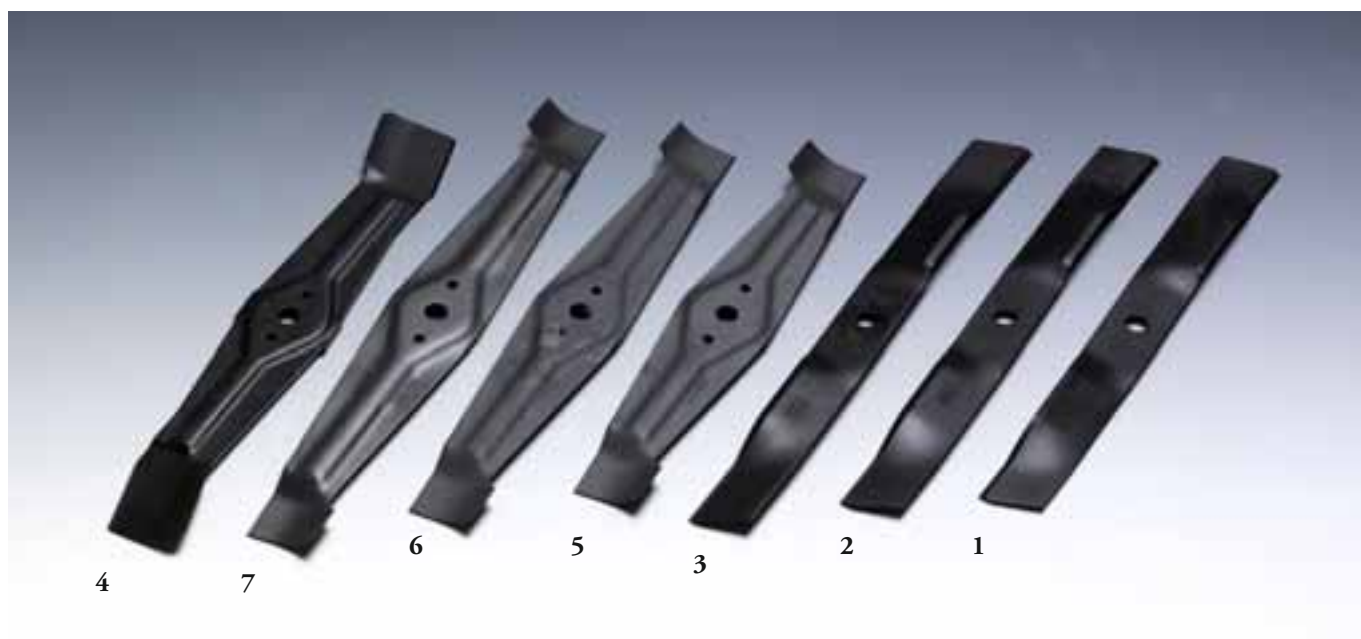

Pos	Detaljnr.	Benämning	Passar till	Innehåller
1	1111-9133-01	Kniv	Multiclip Pro 46	81004130/0
2	1111-9131-01	Kniv	Multiclip 48-Pro 48	81004137/0
3	1111-9132-01	Kniv	Multiclip 51S/53S/53S Rental /Pro 51S/Pro 53S Svan (2009-)/Pro 53 4S Svan (2011-)	81004139/0
4	1111-9128-01	Kniv	Tornado Pro 51 S	1111-2598-02
5	1111-9166-01	Kniv	Turbo 45 S	81004132/0
6	1111-9129-01	Kniv	Turbo Pro 48S/50S/50S Rental	81004135/0
7	1111-9130-01	Kniv	Turbo Pro 55S/Pro 55 4S /55S Rental	81004134/0

KNIVAR - KNIVTALLRIKAR (ROTOR, SIDOUTKAST)

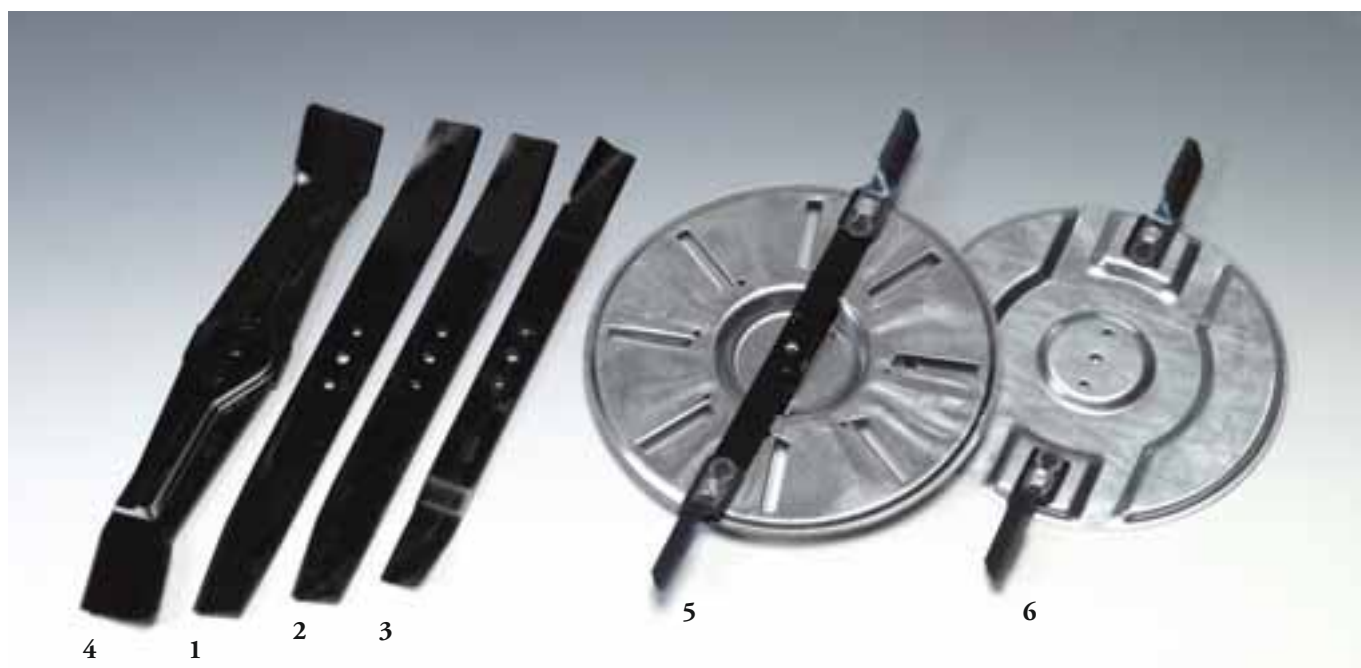

Pos	Detaljnr.	Benämning	Passar till	Anm.
1	1111-9027-01	Kniv	Rotorklippare 20"	1111-1427-01
2	1111-9027-02	Kniv	Rotorklippare 19"	1111-0108-00
3	1111-9502-01	Kniv	Dino	81004124/1
4	1111-9094-01	Kniv	Tornado	1111-2598-01
5	1111-9024-01	Knivtallrik	Tornado	
6	1111-9025-01	Knivtallrik	Dino	

KNIVFÄSTEN



Pos	Detaljnr.	Benämning	Passar till	Anm.
1	1111-9023-01	Knivfäste	Popular, Dino, Collector	1111-0107-00
2	1111-9023-02	Knivfäste	Dino, Tornado, Multiclip 48	1111-0014-00
3	1111-9054-01	Knivfäste	Collector, Multiclip	1111-1765-01
4	1111-9066-01	Knivfäste	Multiclip 46, Dino	22465617/0
5	1111-9067-01	Knivfäste	Multiclip 46S-Pro 46, Tornado 51S, Multiclip 51S-Pro 51S	22465620/0
6	1111-9112-01	Knivfäste	Multiclip 51S-Pro 51S	1111-3297-01
7	1111-9119-01	Knivfäste	Multiclip 51S/53S-Pro 51S (-2009)	22465623/0
8	1111-9070-01	Knivfäste (Ø 22,2)	Turbo 43/45-48/50-55; Multiclip Pro 48	22465618/0
8	1111-9181-01	Knivfäste (Ø 25)	Turbo 55S Honda (2008-)	122465630/0

Anm. Ø 22,2 resp. Ø 25 anger diametern (i mm) på hålet för motoraxeln.

KNIVFÄSTEN



Pos	Detaljnr.	Benämning	Passar till	Anm.
1	1111-9074-01	Knivfäste	Turbo 45, Collector 45, Euro 45, Combi 45	810013381/0
2	1111-9120-01	Knivfäste (Ø 22,2)	Collector 53S, Razer, 46S, 46PD, Razer 48S, Multiclip 50S/50S B/50S Plus/Euro, Turbo 47S/48 S BW Plus B /53S/53 S BW Plus B, Combi 48S/SQ BW/53 SQ-SEQ BW, Turbo Excel 50S/50SE B/ 55S B (2010-)	122465607/3
2	1111-9180-01	Knivfäste (Ø 25)	Turbo 48/53 S BW Plus Honda (2010-)	122465608/1
3	1111-9168-01	Knivfäste (Ø 22,2)	Multiclip 50 (2009-)/50 Plus/Euro, Turbo 47/48 Plus B (2011-), Collector 53, Combi 48 (2010-)	22463012/2
3	1111-9179-01	Knivfäste (Ø 25)	Multiclip 50 Honda (2008-), Turbo 48 Plus Honda (2011-)	122463020/1
4	1111-9165-01	Knivfäste	Multiclip 50 EL/50 el Swan (2010-), Collector 46-48 el, Combi 48 el (2011-)	22463186/2
5	22465622/0	Knivfäste	Multiclip 46 el	
6	22465602/0	Knivfäste/fläkt	Collector 35/39 el, Turbo 39/41 el	
6	22465603/0	Knivfäste/fläkt	Silent 33/41 el, Ladybird 33/41 el	
7	1134-9159-01	Knivfäste (Ø 20)	SC 9214, SD 9812/9814 H/10816, ST 10216 H, Garden Combi, Estate, Overland, Grand Overland åkgräsklippare	25463200/0

FRIKTIONSKNIVFÄSTEN



Pos	Detaljnr.	Benämning	Passar till	Innehåller
1	1111-9126-01	Knivfäste (Ø 22,2)	Multiclip Pro 46, Multiclip 48, Multiclip 51S/53S-Pro 51S/53 S Rental, Tornado Pro 51S	22465621/0
1	122465632/0	Knivfäste (Ø 25)	Multiclip 53S Honda (2008-)/Pro 53 S/4S Svan (2010-)	
2	1111-9127-01	Knivfäste (Ø 22,2)	Multiclip Pro 48, Turbo Pro 48S/50S-Pro 55S/50S Rental (2010-), 55S Rental (2011-)	22465619/0
2	122465631/0	Knivfäste (Ø 25)	Turbo Pro 50S Honda (2008-)	
3	1111-9163-01	Knivfäste (Ø 22,2)	Multiclip 50 Rental, Pro (2006-), Multiclip 50S Silent (2008-), Multiclip 50 S Rental (2010-), Multiclip 50 S/SE Rental B/Special B (2011-)	22465611/0
3	122465612/1	Knivfäste (Ø 25)	Multiclip 50 Rental/Pro Honda (2008-)/Pro 50 Svan (2010-)/Pro 50 S Svan (2009-)/Pro 4S Inox Svan (2009)	
4	22672110/1	Friktionsbricka	Ø= 60 mm	
5	22672111/0	Friktionsbricka	Ø= 55 mm	
6	122465636/0	Knivfäste (Ø 22,2)	Turbo 55 AVS	
6	122465637/0	Knivfäste (Ø 25)	Turbo 55 AVS/Pro 55 4S (2011-)	

KNIV - KNIVFÄSTE (TURBO EXCEL 50, TURBO HD 60, TURBO EXCEL 2010)

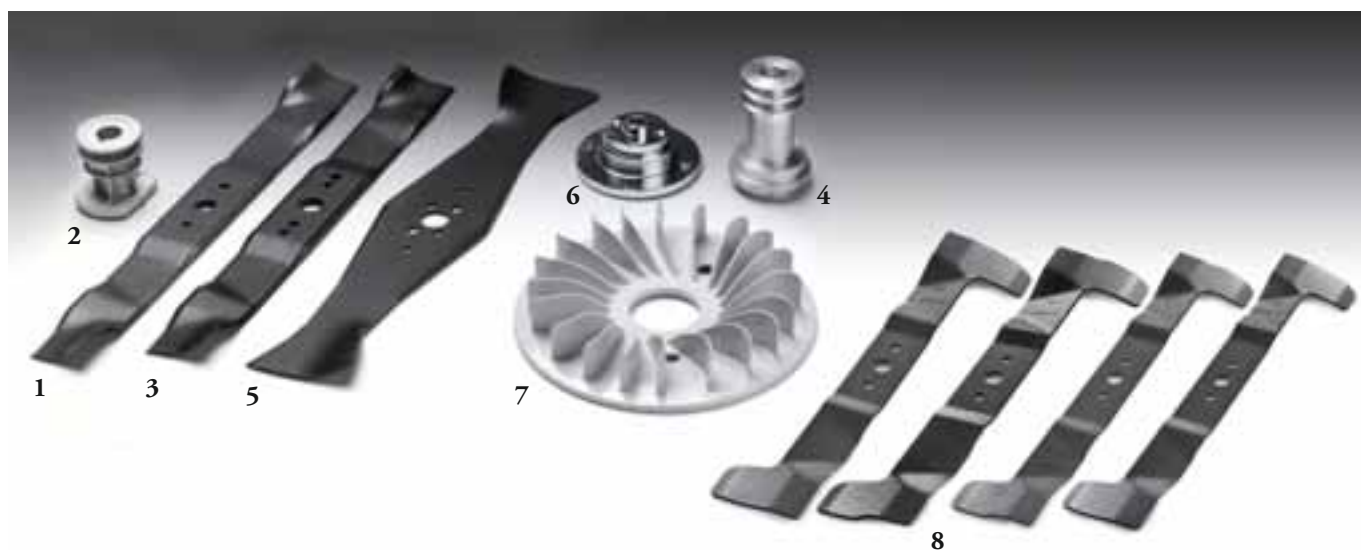

Pos	Detaljnr.	Benämning	Passar till	Innehåller
1	1111-9192-01	Kniv	Turbo Excel 50 (2009)	81004366/2
2	1111-9182-01	Knivfäste (Ø 22,2)	Turbo Excel 50 AVS (2009)	122465638/0
2	1111-9183-01	Knivfäste(Ø 25)	Turbo Excel 50 AVS (2009-)/50 S H AVS (2010-)/55 S H AVS (2010-)	122465639/0
3	1111-9186-01	Kniv	Turbo Excel 50 AVS, Excel 50 BBC	181004368/0
4	122465643/0	Knivfäste	Turbo HD 60 MB	
5	1111-9185-01	Kniv	Turbo HD 60 MB, 60 MHV	181004149/0
6	122465641/0	Knivfäste	Turbo HD 60 MHV	
7	25041	Fläkt	Turbo HD 60 MB, 60 MHV	
8	1111-9188-01	Kniv	Turbo Excel 50 S B (2010-) - Turbo Excel 50 SE B (2010-)	181004450/0
8	1111-9189-01	Kniv	Turbo Excel 50 S H AVS (2010-)	181004451/0
8	1111-9190-01	Kniv	Turbo Excel 55 S B (2010-)	181004453/0
8	1111-9191-01	Kniv	Turbo Excel 55 S H AVS (2010-)	181004454/0

DRIVREMMAR

Detaljnr.	Passar till	Innehåller
1111-9051-01	Turbo 460S, Multiclip S	1151-0128-01
1111-9052-01	Turbo 510S, Multiclip Pro 511S	1151-0128-05
1111-9053-01	Turbo 43/45, Tornado	35063173/0
1111-9056-01	Turbo 420S-420 el	1151-0128-07
1111-9057-01	Turbo 530S	9585-0074-00
1111-9058-01	Collector 46S	9585-0080-00
1111-9059-01	Tornado 90S	1151-0128-09
1111-9060-01	Multiclip 46S	1151-0128-10
1111-9061-01	Turbo 48S/50S/Turbo 50S Rental (2011-), Collector 48S	35063175/0
1111-9062-01	Multiclip Pro 51S	1151-0128-12
1111-9063-01	Tornado 51S-Pro 51S	1151-0128-13
1111-9064-01	Turbo 55S, Collector 55S	9585-0049-00
1111-9065-01	Turbo 48S (4-speed)	9585-0086-00
1111-9104-01	Multiclip Pro 51S	1151-0128-15
1111-9107-01	Collector 45S, Turbo 45S, Euro 45S, Combi 45S	1117-1113-01
1111-9113-01	Multiclip 51S/53S-Pro 51S	1151-0128-16
1111-9114-01	Combi 45S, Collector 45S, Turbo 45S, Silent 45S el	35064000/0
1111-9123-01	Razer, 46S, 46PD, Turbo 47S, Collector 46S Roller, Razer 48S, Collector 43S/46S/48S, Combi 48S/48 SQ BW/48 SQ BW B, Turbo 48 S BW Plus B/H	35063800/0
1111-9124-01	Collector 53S, Combi 53S/53 SQ BW/53 SEQ BW (2010-), Turbo 53S/53S BW Plus (2010-); Multiclip 50S/50S Plus/50S Rental/50S Special B/50S H/Pro 50 S Svan	35063902/0
1111-9125-01	Multiclip 46S	1151-0128-17
1111-9164-01	Turbo 53S 4S, Multiclip 50 4S/Pro 50 4S Inox Svan, Multiclip 53S/53S Rental/Pro 53 S Svan	35064010/0
1111-9167-01	Turbo 55S/55 S Rental B (2011-)/Pro 55 4S (2011-), Collector 55S, Multiclip 53S 4S/Pro 53 4S Svan	35064383/0
1111-9202-01	Turbo 43S (4-speed)	35064373/0
1111-9203-01	Turbo 48S (4-speed)	35064378/0
1111-9198-01	Collector 46S	35063750/0
1111-9199-01	Club Garden 46S	35063900/0
1111-9200-01	Collector 53S, Combi 53S	35064100/0
1111-9201-01	Turbo Excel 50	35064150/0
1111-9197-01	Turbo Excel 50 variospeed	135064384/0
135064391/0	Turbo Excel 50 S/SE/ S H AVS (2010-)	
135064392/0	Turbo Excel 55 S/S H AVS (2010-)	
1111-9195-01	Turbo HD 60 MHV	14586
1111-9196-01	Turbo HD 60 MB	155007



DRIVREMMAR FÖR VERTIKALSKÄRARE/MOSSRIVARE

Detaljnr.	Passar till
1716-0221-01	VE 30, RE 30
1716-0015-01	VE 32
1319-1918-01	VB 40 (Kevlar)

DRIVREMMAR FÖR JORDFRÄSAR

Detaljnr.	Passar till
1483-2137-01	Silex 360-G
1483-2113-01	Silex 500-G, 500R-G
1483-2114-01	Silex 500R-G
1483-2034-01	Silex 40-G, 40R-G
1483-2036-01	Silex 40R-G, 50R-B
1483-2035-01	Silex 50-G, 50-H, 50R-B
1483-2141-01	Silex 75R-B, 75R-H, 75R-HX
1483-2149-01	Silex 75-G, 75R-B, 75R-H, 75R-HX
1483-2263-01	Silex 82R-HX
1483-2264-01	Silex 82R-HX
1483-2350-01	Silex 87B slätterbalk
1483-2352-01	Silex 87B/95B/95H slätterbalk
118800001/0	95 B / 95 H

REMHÅLLARE

Detaljnr.	Passar till
8290-0065-01	Remhållare
8290-0066-06	Etikettsats d:o (ark nr. 1-8)
8290-0087-01	Etikettsats d:o (ark nr. 9)
8290-0087-02	Etikettsats d:o (ark nr. 10-11)



REGLAGEWIRAR

GASWIRE

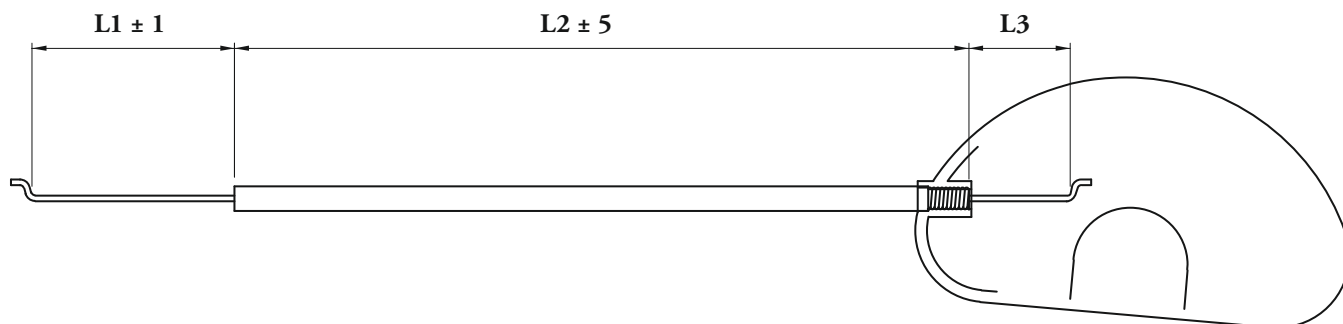

Detaljnr.	Benämning	Passar till	Anm. (mm)
81007080/0	Gaswire	Dino 47; Multiclip 53 S Rental B (2011-)/50/50 B/50S Plus/50S Rental/50SE Rental B/50S Special B (2011-)	L1= 50 - L2= 1755 L3= 25

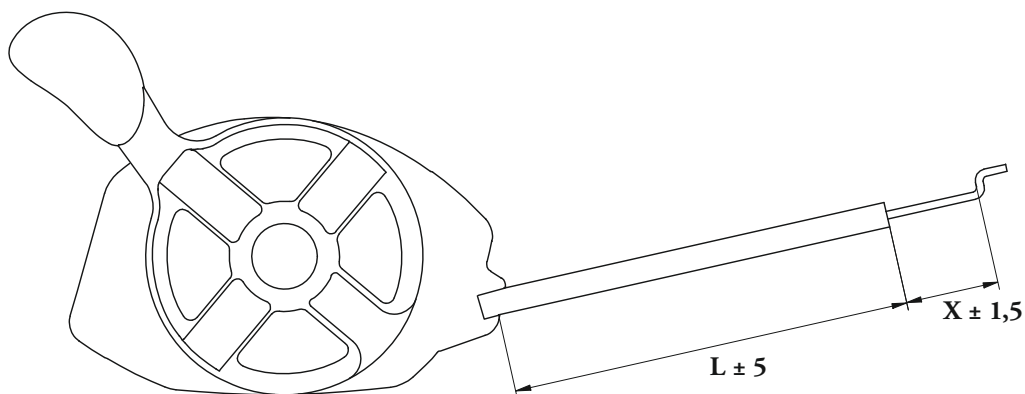

Detaljnr.	Benämning	Passar till	Anm. (mm)
181005501/1	Gaswire	Combi 48 SQ BW/ Combi 53 SQ BW/53 SEQ BW / Turbo X3 50 S (2011-)	L= 1100 - X= 54
181005502/1	Gaswire	Combi 48 SQ BW B - Combi 53 SQ BW B - Turbo 53 S BW Plus B - Turbo Excel 50 S B/50 SE B (2011-)	L= 1440 - X= 48
181005503/1	Gaswire	Turbo X3 50 S H (2011-)	L= 1480 - X= 54
181005509/0	Gaswire	Turbo Excel 55 S B; Turbo X3 55 S B (2011-)	L= 1480 - X= 54
181005513/0	Gaswire	Turbo 53 S BW Plus H (2011-)	L= 1070 - X= 54
181005514/0	Gaswire	Turbo 48 Plus H (2011-)	L= 1035 - X= 54
181005515/0	Gaswire	Turbo 48 S BW Plus H (2011-)	L= 1035 - X= 54
181005516/0	Gaswire	Turbo 48 Plus B; Turbo 48 S BW Plus B (2011-)	L= 1390 - X= 48

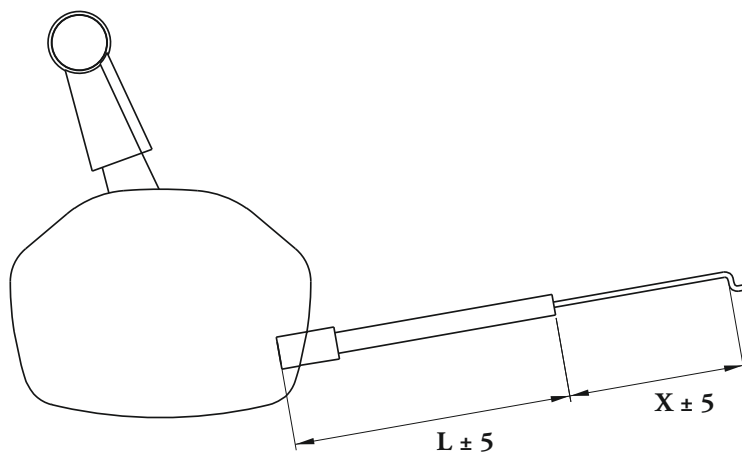

Detaljnr.	Benämning	Passar till	Anm. (mm)
181007125/0	Gaswire	Turbo 50 S Rental H (2011-)	L= 1040 - X= 37
81007130/0	Gaswire	Multiclip 50 S H (2011-)	L= 1010 - X= 37

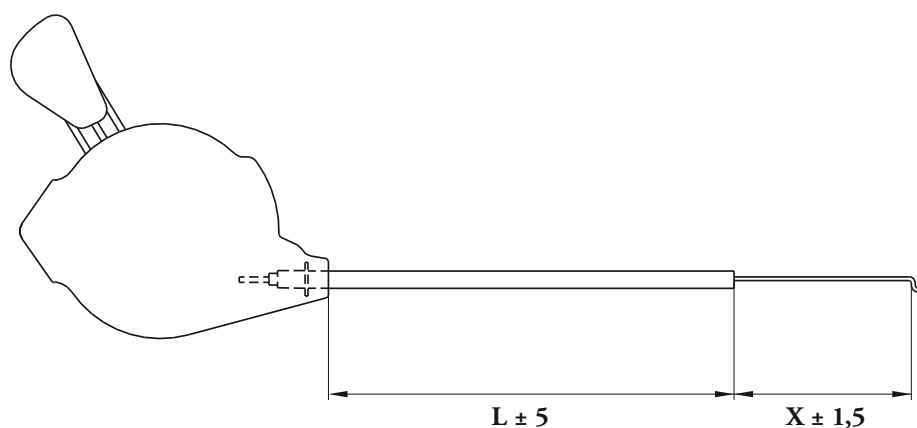

Detaljnr.	Benämning	Passar till	Anm. (mm)
81007128/0	Gaswire	Turbo 50 S Rental B (2011-)	L= 1270 - X= 60
181007132/0	Gaswire	Turbo 55 S Rental B (2011-)	L= 1380 - X= 60

MOTORBROMSWIRAR

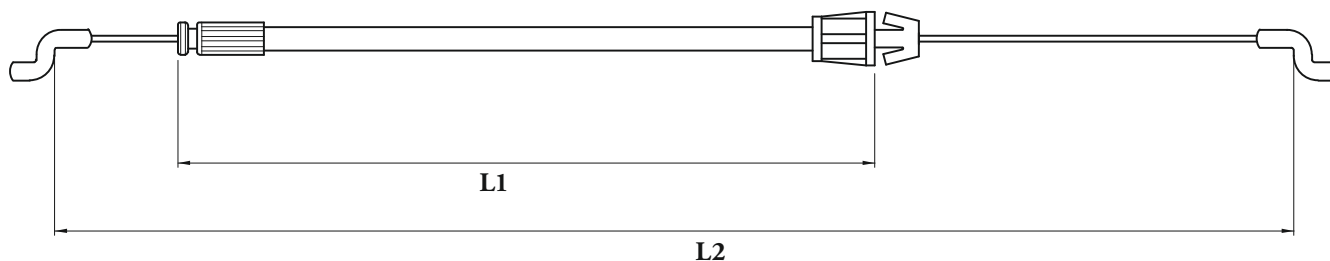

Detaljnr.	Benämning	Passar till	Anm. (mm)
81000692/0	Motorbromswirar	Turbo 50 S Rental B- Turbo 55 S Rental B (2011-)	L1= 1050 - L2= 1277
81000730/0	Motorbromswirar	Multiclip 53 S Rental B (2011-)	L1= 930 - L2= 1157
181000769/1	Motorbromswirar	Multiclip Pro 50 Svan/Pro 50 S Svan/Pro 50 4S Inox Svan/Pro 53 S Svan/Pro 53 4S Svan (2011-)	L1= 970 - L2= 1206
181030065/0	Motorbromswirar	Turbo Excel 50 S B/50 SE B/55 S B; Turbo X3 50 S/X3 50 S H/X3 55 S B (2011-)	L1= 1185 - L2= 1372
181030061/0	Motorbromswirar	Turbo 50 S Rental H; Turbo Pro 55 4S (2011-)	L1= 1050 - L2= 1282
181030066/0	Motorbromswirar	Turbo Excel 50 S H AVS/Excel 55 S H AVS/ Excel 55 S H BBC (2011-)	L1= 1150 - L2= 1374
181030053/0	Motorbromswirar	Combi 48 SQ BW; Combi 53 SQ BW; Combi 53 SEQ BW; Combi 48 SQ BW B; Combi 53 SQ BW B (2011-)	L1= 1150 - L2= 1313
181030073/0	Motorbromswirar	Turbo 48 Plus B/48 S BW Plus B/48 Plus H/48 S BW Plus H (2011-)	L1= 1085 - L2= 1241
181000733/0	Motorbromswirar	Multiclip 50 S H (2011-)	L1= 927 - L2= 1101
181030074/0	Motorbromswirar	Turbo 53 S BW Plus B; Turbo 53 S BW Plus H (2011-)	L1= 1125 - L2= 1311
181000618/0	Motorbromswirar	Multiclip 50 Rental B/50 S Rental B/50 SE Rental B/50 S Special B/50 Plus/50 S Plus/50 S Rental (2011-)	L1= 1000 - L2= 1227

MOTORBROMSWIRAR

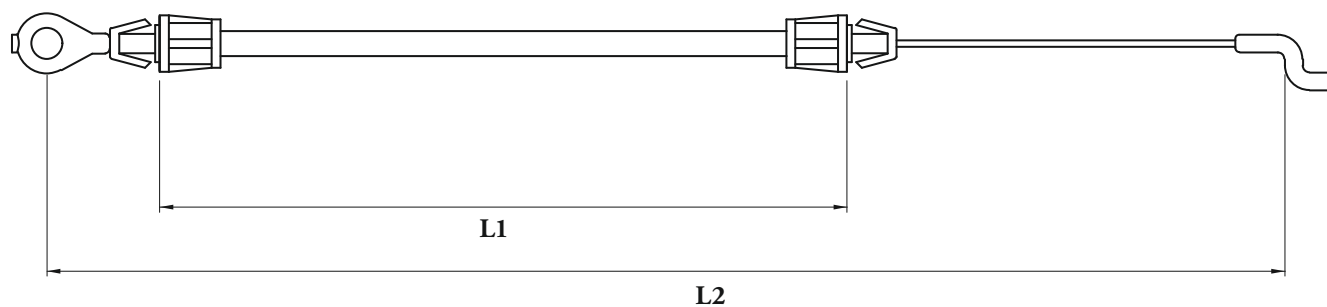

Detaljnr.	Benämning	Passar till	Anm. (mm)
81000631/0	Motorbromswirar	Multiclip 50 B/50 S B (2011-)	L1= 1022 - L2= 1215
81000634/0	Motorbromswirar	Multiclip 50; Multiclip 50 S (2011-)	L1= 1040 - L2= 1233

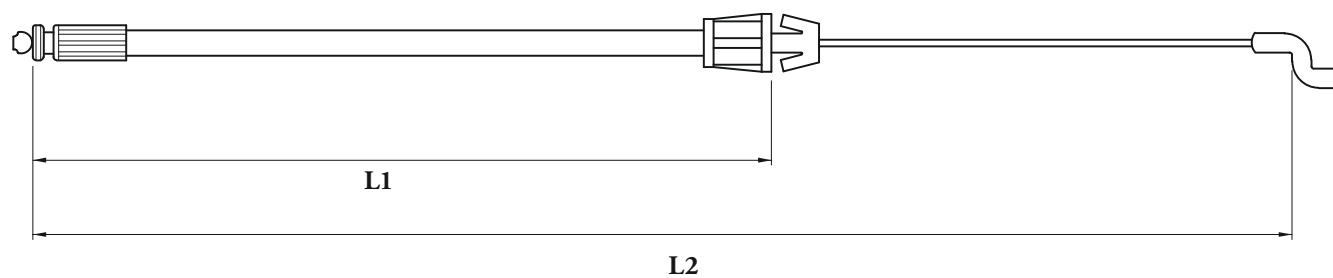

Detaljnr.	Benämning	Passar till	Anm. (mm)
81000685/0	Motorbromswirar	Dino 47 (2011-)	L1= 935 - L2= 1205

KOPPLINGSWIRE

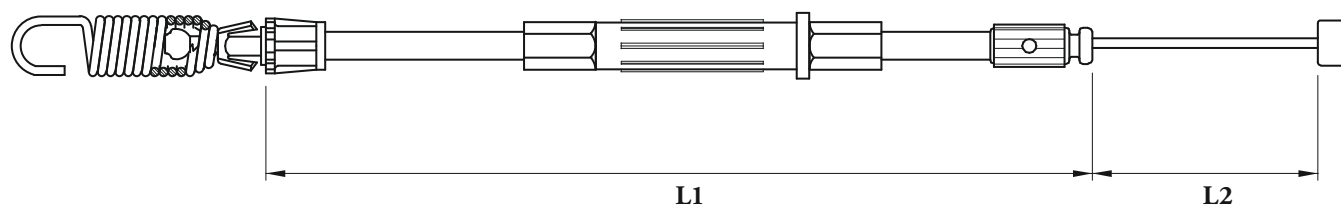

Detaljnr.	Benämning	Passar till	Anm. (mm)
81000697/0	Kopplingswire	Turbo 50 S Rental B/55 S Rental B/50 S Rental H/ Pro 55 4S (2011-)	L1= 1300 - L2= 245

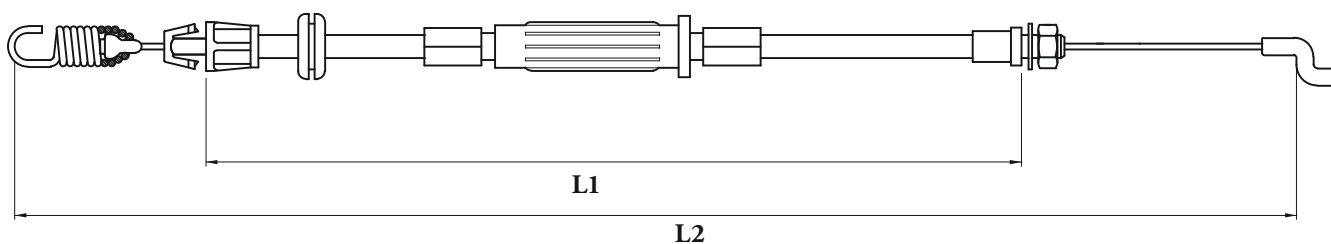

Detaljnr.	Benämning	Passar till	Anm. (mm)
81000734/1	Kopplingswire	Multiclip 50 S; Multiclip 50 S B (2011-)	L1= 1510 - L2= 1774

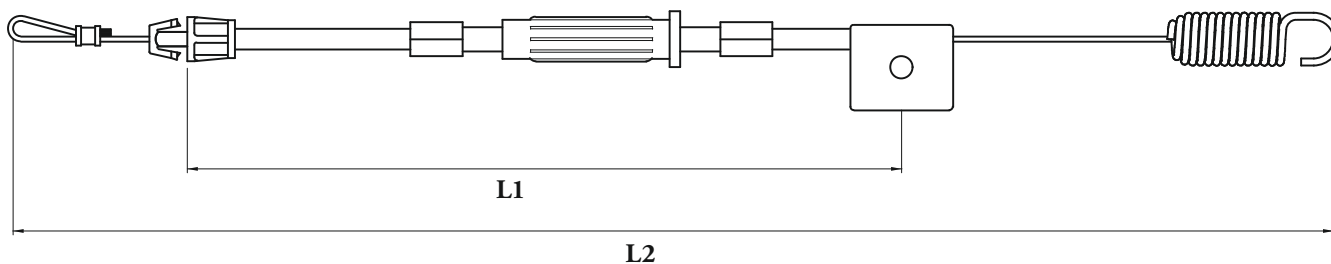

Detaljnr.	Benämning	Passar till	Anm. (mm)
381000745/1	Kopplingswire	Multiclip 50 S Rental B/50 SE Rental B/50 S Special B/53 S Rental B/50 S H/Pro 50 S Svan/Pro 53 S Svan/ Pro 53 4S Svan/50 S Plus/50 S Rental (2011-)	L1= 1330 - L2= 1506

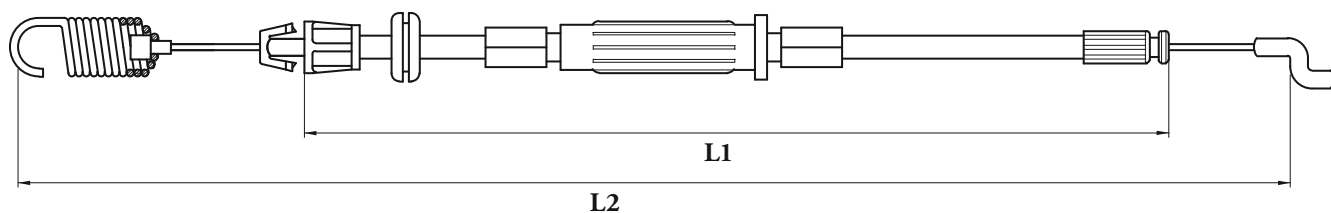

Detaljnr.	Benämning	Passar till	Anm. (mm)
381030067/0	Kopplingswire	Turbo Excel 50 S B/Excel 50 SE B/Excel 55 S B; Turbo X3 50 S; Turbo X3 50 S H; Turbo X3 55 S B (2011-)	L1= 1130 - L2= 1409
381030068/0	Kopplingswire	Turbo Excel 50 S H AVS/Excel 55 S H AVS/Excel 55 S H BBC (2011-)	L1= 1100 - L2= 1414
381030051/0	Kopplingswire	Combi 48 SQ BW/48 SQ BW B /53 SQ BW/53 SEQ BW/ Combi 53 SQ BW B (2011-)	L1= 1170 - L2= 1361
381030075/0	Kopplingswire	Turbo 48 S BW Plus B/48 S BW Plus H; Turbo 53 S BW Plus B/53 S BW Plus H (2011-)	L1= 1137 - L2= 1409

STARTBATTERIER



Pos	Detaljnr.	Passar till	Anm.
1	18120052/0	Combi 48SE/53 SE BW (2009-)/53 SEQ BW (2011-); Turbo 45 S Rental (2009-)/48 SE BW (2009-)/50SE/SE Pro/50 Rental/Excel 50 SE/53 SE BW/55SE/55SE Rental/Pro 55; Multiclip 50SE/50SE Rental/Pro 50 Svan/53 SE/53SE Rental/Pro 53 Svan/53 Plus; Collector 53 SE BW (2008-)/SE 53 (2007-)	12V 4AH
2	18120053/0	Collector 46S/53SE (2008-); Combi 46S/53S (2009-)	12V 4,5AH
3	18204120/0	18120052/0; 18120053/0	
3	18204121/0	18120052/0; 18120053/0	UK kontakt

KNIVAR 85M - 102M - 121M (-1997)



Pos	Detaljn.	Benämning	Passar till	Anm.
1	1134-9038-01	Kniv	Villa 85M	2-pack
1	1134-9039-01	Kniv	Park 121M	3-pack
2	1134-9002-01	Kniv	Villa 102M, Park 100M, 102M	3-pack

Anm. 1134-9038-01 och 1134-9039-01 innehåller exakt samma kniv fast i olika antal.

KNIVAR 85M - 102M - 121M (1998 - 2002)

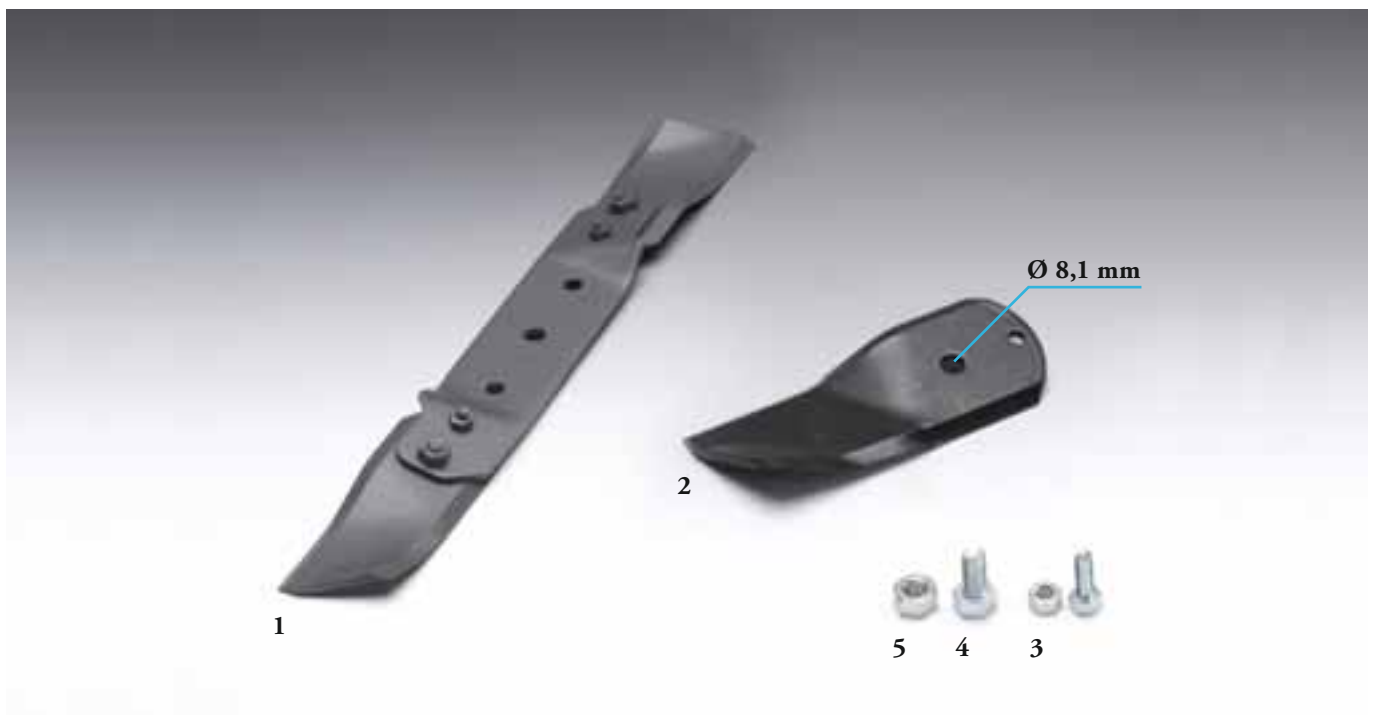

Pos	Detaljn.	Benämning	Passar till	Anm.
1	1134-9052-01	Knivbalk	Park 102M, Villa 102M	3-pack (kort knivbalk)
2	1134-9053-01	Knivspetsar		
3	1134-9054-01	Brytbultsats		
4	9997-0816-16	Bult M8		
5	9712-0831-02	Låsmutter M8		

Anm. Knivspetsarna monterade på undersidan av knivbalken.

KNIVAR 85M - 121M (2003 - 2007)

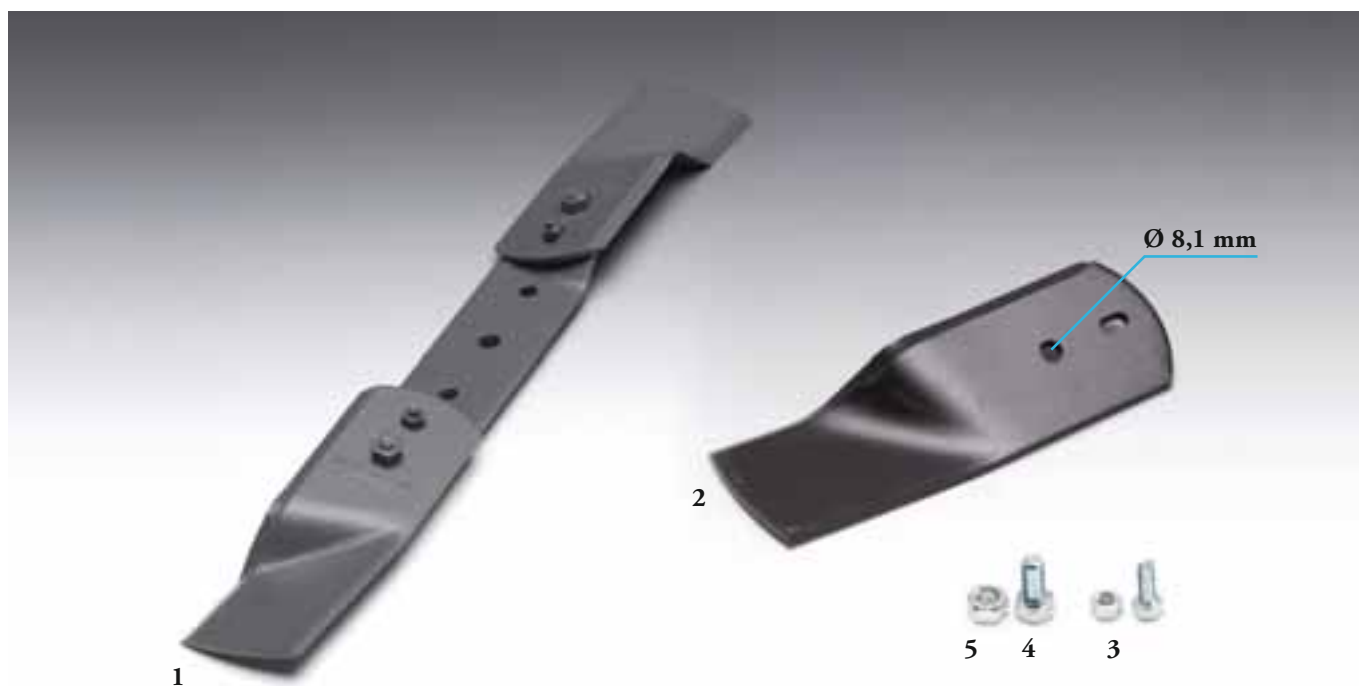

Pos	Detaljnr.	Benämning	Passar till	Anm.
1	1134-9080-01	Knivbalk	Ready 85M, Villa 85M	Package of 2
1	1134-9081-01	Knivbalk	Park 121M	Package of 3
2	1134-9082-01	Knivspetsar		
3	1134-9054-01	Brytbultsats		
4	9997-0816-16	Bult M8		
5	9712-0831-02	Låsmutter M8		

Anm. 1134-9080-01 och 1134-9081-01 innehåller exakt samma knivbalk fast i olika antal. Knivspetsarna monterade på översidan av knivbalken.

KNIVAR 92M - 107M (2001)



Pos	Detaljnr.	Benämning
1	1134-9063-01	Knivspetsar (cw)
2	1134-9063-02	Knivspetsar (ccw)
3	1134-9054-01	Brytbultsats
4	1134-4479-01	Ansatsbult
5	9712-0831-02	Låsmutter M8

Anm. cw = medurs rotation, ccw = moturs rotation

KNIVAR 92M - 107M (2000 - 2006)

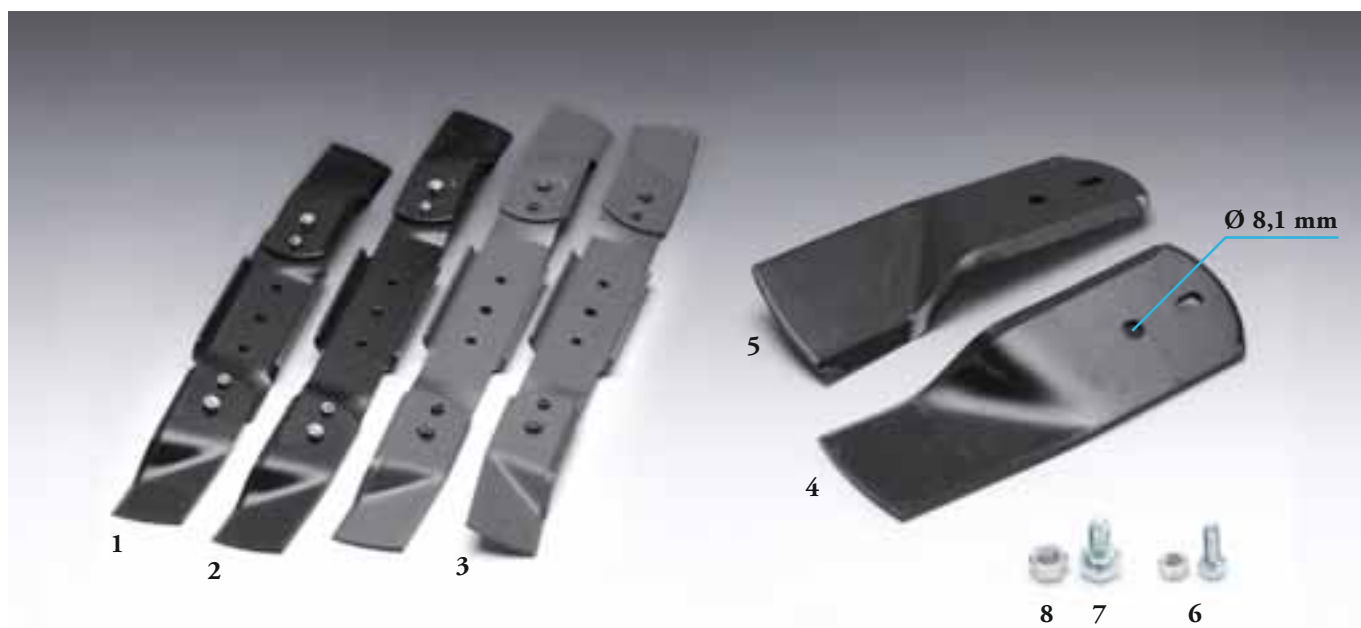

Pos	Detaljnr.	Benämning	Passar till	Anm.
1	1134-9073-01	Knivbalk	Ready 92M, Villa 92M, Park 92M	2-pack (cw + cw)
2	1134-9072-01	Knivbalk	Villa 107M, Park 107M	2-pack (cw + cw)
3	1134-9077-01	Knivbalk	Villa 107M, Park 107M	2-pack (cw + ccw)
4	1134-9074-01	Knivspetsar (cw)		
5	1134-9074-02	Knivspetsar (ccw)		
6	1134-9054-01	Brytbultsats		
7	1134-4479-01	Ansatsbult		
8	9712-0813-02	Låsmutter M8		

Anm. 1134-9073-01, 1134-9072-01 och 1134-9077-01 har ersatts av knivbalkarna med grov 7/16" fästbult. 1134-9074-01 och 1134-9074-02 har ersatts av knivspetsarna med grov 7/16" fästbult.

KNIVAR 92M - 107M (2000 - 2006)



Pos	Detaljnr.	Benämning	Passar till	Anm.
1	1134-9120-01	Knivbalk	Ready 92M, Villa 92M, Park 92M	2-pack (cw + cw)
2	1134-9121-01	Knivbalk	Villa 107M, Park 107M	2-pack (cw + cw)
3	1134-9122-01	Knivbalk	Villa 107M, Park 107M	2-pack (cw + ccw)
4	1134-9123-01	Knivspetsar (cw)		
ej ill	1134-9123-02	Knivspetsar (ccw)		
5	1134-9054-01	Brytbultsats		
6	1134-6311-01	Bult 7/16" UNF		
7	1134-6312-01	Låsmutter 7/16" UNF		

Anm. Knivbalkar och knivspetsar avsedda för grövre fingängad bult.

KNIVAR 85 COMBI - 95 COMBI - 105 COMBI (2007-)



Pos	Detaljnr.	Benämning	Passar till	Anm.
1	1134-9116-01	Knivbalk	Ready 85 Combi, Villa 85 Combi	2-pack
2	1134-9117-01	Knivbalk	Villa 95 Combi, Park 95 Combi	2-pack
3	1134-9118-01	Knivbalk	Park 105 Combi	2-pack
4	1134-9119-01	Knivspetsar		
5	1134-9054-01	Brytbultsats		
6	1134-6311-01	Bult 7/16" UNF		
7	1134-6312-01	Låsmutter 7/16" UNF		

KNIVAR 110 COMBI - 125 COMBI (2004-)



Pos	Detaljnr.	Benämning	Passar till	Anm.
1	1134-9107-01	Kniv	Park 110 Combi (2006)	3-pack
2	1134-9124-01	Kniv	Park 110 Combi (2007-)	3-pack
3	1134-9086-01	Kniv	Park 125 Combi (2004-2006)	3-pack
4	1134-9125-01	Kniv	Park 125 Combi (2007-)	3-pack
5	1134-9158-01	Kniv	Park 100 Combi 3 (2011-)	3-pack

Anm. Knivarna 1134-9107-01 och 1134-9086-01 har tre fastsättningshål. Knivarna 1134-9124-01 och 1134-9125-01 har ett centrumhål.

KNIVAR (GARDEN, VILLA, PARK SIDO-, BAKUTKAST)



Pos	Detaljnr.	Benämning	Passar till	Anm.
1	1134-3935-01	Kniv	Garden Combi	
2	1134-3743-01	Kniv	Garden 72M Multiclip	
3	1134-3222-02	Kniv	Garden 72S Collector	
4	1134-3222-01	Kniv	Garden 65S, Scoop	
5	1134-2061-01	Kniv	Garden 65B, Scoop	
6	1134-0913-01	Kniv	Park 122B	
7	1134-2574-01	Kniv	Park 110S	
8	1134-9001-01	Kniv	Park 100B	3-pack
9	1134-9003-01	Kniv	Villa 85B	3-pack

KNIVFÄSTEN



Pos	Detaljnr.	Benämning	Passar till	Anm.
1	1134-9000-01	Knivfäste kpl	Park, Villa, Garden, Scoop	3-pack
1	1134-9061-01	Knivfäste kpl	Park, Villa, Garden, Scoop	1-styck
2	1134-0323-01	Kil		L: 12 mm
3	9600-0150-01	Kil		L: 16 mm
4	9991-1024-19	Knivbult		
5	9959-0830-16	Knivbult		
6	12293201/0	Mutter för d:o		
7	1134-3544-01	Fiberbricka	85M, 102M, 121M, Garden 72M Multiclip, Garden Combi	
8	9699-0109-02	Planbricka d:o		
9	1134-3744-01	Knivfäste	Garden 72M Multiclip, Garden Combi	

Anm. Knivfäste kpl (pos 1) innehåller pos. 2 - 6.

KNIVAR (GARDEN - ESTATE)



Pos	Detaljnr.	Benämning	Passar till	Klippbredd
1	84109504/0	Kniv	Garden Compact/Compact Pro EV (2011-), SR 6365/6365 EV (2011-)	63 cm
2	84109503/0	Kniv	Garden Combi/Garden Combi HST 14/Pro HST 13	72 cm
3	84109502/0	Kniv	Garden Combi/Garden Combi HST 14/Pro HST 13	72 cm
4	82004346/0	Kniv	Estate Tornado/Estate Tornado 14/HST 17/Pro HST 13; SD 9813; SD 9812 (2011-); SD 9814 H (2011-)	98 cm

Anm. Knivfäste för d:o (detaljnr. 25463200/0), se sid 5. Klippbredden anger maskinens totala klippbredd, ej knivens längd.

KNIVAR (ESTATE)



Pos	Detaljnr.	Benämning	Passar till	Klippbredd
1	82004353/0	Kniv-vä	Estate Collector/President/Senator/Senator 14/HST 17/Pro HST 17 (2011-);SC 9013/9214	92 cm
1	82004354/0	Kniv-hö	Estate Collector/President/Senator/Senator 14/HST 17/Pro HST 17 (2011-);SC 9013/9214	92 cm
2	81004346/3	Kniv-vä	Estate Collector, Senator,President, SC 9013/9214 (2011-)	92 cm
2	82004352/0	Kniv-hö	Estate Collector, Senator,President, SC 9013/9214 (2011-)	92 cm
3	82004344/1	Kniv-vä	Estate Collector, Senator,President; SC 9013/9214 (2011-)	92 cm
3	82004345/1	Kniv-hö	Estate Collector, Senator,President; SC 9013/9214 (2011-)	92 cm
4	82004347/0	Kniv-vä	Estate Royal/Royal 19 (2010-)/Pro 17 (2010)- Pro - Overland/Overland 22 4WD (2010-) ST 10214/ST 10216 H (2011-)	102 cm
4	82004348/0	Kniv-hö	Estate Royal/Royal 19 (2010-)/Pro 17 (2010)- Pro - Overland/Overland 22 4WD (2010-) ST 10214/ST 10216 H (2011-)	102 cm
4	82004349/0	Kniv-vä	Estate Grand Royal 22 - Grand Overland 24E/24 4WD/Pro 25 4WD E (2010-)	122 cm
4	82004350/0	Kniv-hö	Estate Grand Royal 22 - Grand Overland 24E/24 4WD/Pro 25 4WD E (2010-)	122 cm
5	182004357/0	Kniv	SD 10816; Estate Grand Tornado 17/HST 19/Pro HST 17 (2011-)	108 cm
6	82004340/0	Kniv-vä	Estate Royal/Royal 19 (2010-)/Pro 17 (2010-); Pro; Overland/Overland 22 4WD (2010-); ST 10214	102 cm
6	82004341/0	Kniv-hö	Estate Royal/Royal 19 (2010-)/Pro 17 (2010-); Pro; Overland/Overland 22 4WD (2010-); ST 10214	102 cm
6	82004342/0	Kniv-vä	Estate Grand Royal 22; Grand Overland 24E/24 4WD/Pro 25 4WD E (2010-)	122 cm
6	82004343/0	Kniv-hö	Estate Grand Royal 22; Grand Overland 24E/24 4WD/Pro 25 4WD E (2010-)	122 cm

LAGERBOXAR (-1997)



Pos	Detaljnr.	Benämning	Passar till	Anm.
1	1134-0428-01	Lagerbox kpl	Park 100B, 110S, Villa 85B	Yttre
2	1134-0428-02	Lagerbox kpl	Villa 85B	Mittre
3	1134-0430-01	Lagerbox kpl	Park 100B, 110S	Mittre
4	1134-2476-01	Lagerbox kpl	Park 100M	Yttre
5	1134-2477-01	Lagerbox kpl	Park 100M	Mittre
6	1134-3696-01	Lagerbox kpl	Park 102M, 121M, Villa 85M, 102M	Yttre
7	1134-3696-02	Lagerbox kpl	Park 102M, 121M, Villa 85M, 102M	Mittre
8	9945-0825-16	Bult för d:o		Självgång
9	20001215/0	Kullager-övre	Passar även lagerboxar 1998- (se nedan)	
10	9549-0020-00	Kullager-nedre	Passar även lagerboxar 1998- (se nedan)	
11	1134-0400-01	Täckbricka		

LAGERBOXAR - KNIVAXLAR (1998 -)



Pos	Detaljnr.	Benämning	Passar till	Anm.
1	1134-3841-01	Lagerbox (m. lager)	Park 100B, 102M, 121M, Villa 85M, 102M	Utan knivaxel
2	1134-5049-01	Lagerbox (m. lager)	Park 92M, 107M, Villa 92M, 107M, Ready	Utan knivaxel
3	1134-4600-01	Knivaxel	Park 100B, 102M, 121M, Villa 85M, 102M	L= 146 mm
4	1134-4600-02	Knivaxel	Park 102M, 121M, Villa 85M, 102M	L= 168 mm
5	1134-5052-03	Knivaxel	Villa 92M, 107M, Ready	L= 150.5 mm
6	1134-5052-04	Knivaxel	Park 92M, 107M, Villa 92M, 107M, Ready	L= 131.5 mm
7	1134-4775-01	Låsmutter M10	1134-4600-01, 1134-4600-02	
8	9712-1231-02	Låsmutter M12	1134-5052-03, 1134-5052-04	
9	1134-5130-01	Skyddsbricka		
10	1134-3725-01	Distans		L= 12.0 mm
11	1134-3725-02	Distans		L= 9.3 mm
12	1134-3725-04	Distans		L= 25.5 mm

LAGERBOX - KNIVAXEL (107M HD)



Pos	Detaljnr.	Benämning	Passar till	Anm.
1	1134-5128-01	Kuggremskiva	Park 107M HD	
2	9600-0170-00	Plattkil		6 x 6 x 16
3	1134-5127-01	Bricka		8.5 x 30 x 4
4	9958-0820-16	Skruv		M8 x 20
5	1134-5049-02	Lagerbox (m. lager)		Utan knivaxel
6	9549-0056-01	Kullager		
7	1134-5130-02	Skyddsbricka		
8	1134-5124-01	Distans		
9	1134-5126-01	Knivaxel		Ø = 20 mm

LAGERBOX - KNIVAXEL (110, 125 COMBI PRO)



Pos	Detaljnr.	Benämning	Passar till	Anm.
1	1134-5872-01	Lagerbox (m. lager)	Park 110, 125 Combi (-2006)	Utan knivaxel
2	9549-0057-01	Kullager d:o		
3	1134-5401-01	Knivaxel-yttre		Ø = 25 mm
4	1134-5401-02	Knivaxel-centrum		
5	1134-5403-01	Skyddsbricka		
6	1134-5831-01	Lagerbox kpl-yttre	Park 110, 125 Combi (2007-)	Med knivaxel
6	1134-5831-02	Lagerbox kpl-centrum		Med knivaxel
7	1134-6211-01	Knivbricka		
8	9997-1060-12	Knivbult		
9	9945-0825-16	Skruv	För montering av lagerbox	Självgäng.

Anm. Lagerboxarna 1134-5831-01 och -02 passar knivbalkar med ett centrumhål.

LAGERBOX - KUGGREMSKIVOR (85, 95, 105 COMBI)



Pos	Detaljnr.	Benämning	Passar till	Anm.
1	1134-5831-01	Lagerbox kpl		Med knivaxel, Ø=25 mm
2	9945-0825-16	Skruv	För montering av lagerbox	Självgäng
3	1134-6211-01	Knivbricka		
4	9997-1060-12	Knivbult		
5	1134-9127-01	Kuggremskiva m. nav-		Sats 2 st.
6	1134-9128-02	Kuggremskiva u. nav	Park 95C; 105C (2010-)	Endast till aggregat årsmod. 2010
7	9549-0019-00	Kullager	För kuggremskiva pos 6	
8	1137-0116-01	Remskiva	Park 95C (2007-)	Används i stället för 1134-9128-01
8	1137-0116-02	Remskiva	Park 105C (2007-)	Används i stället för 1134-9128-01

PRIMO



Pos	Detaljnr.	Benämning	Passar till	Anm.
1	1134-9129-01	Knivbalk	Primo (2008-)	2-pack
2	1134-9130-01	Knivspetsar		
3	1134-9054-01	Brytbultsats		
4	1134-6311-01	Bult 7/16" UNF		
5	1134-6312-01	Låsmutter 7/16" UNF		
6	1134-6613-01	Lagerbox kpl		Med knivaxel, Ø=20 mm
7	1134-9137-01	Kuggremskiva		Sats 2 st.
8	1134-9139-01	Kåphjul		
9	1134-6565-01	Lyftwire		
10	1134-9138-01	Styrwire		
11	1134-9140-01	Hjulbusning	Framhjulen	Sats 2 st.

Anm. Drivremmar för Primo - se sid. 25-26, batteri för Primo - se sid 27.

KUGGREMSKIVOR (85M, 92M, 102M, 107M, 121M)



Pos	Detaljnr.	Benämning	Passar till	Anm.
1	1134-3679-01	Kuggremskiva	Park 92M, 102M, 107M, 121M, Villa 85M, 92M, 102M, 107M, Ready	Yttre
2	1134-3679-02	Kuggremskiva	Park 102M, 121M, Villa 85M, 102M, Ready	Mittre
3	1134-4321-01	Kuggremskiva	Park 92M, 107M, Villa 107M	En halva
4	1134-0323-01	Kil		L = 25 mm
5	1134-0323-02	Kil		L = 54 mm
6	1134-0323-04	Kil		L = 45 mm
7	9699-0030-02	Planbricka	M10-mutter	10 x 26 x 2
8	9699-0121-02	Planbricka	M12-mutter	12,5 x 35 x 3

SPÄNNRULLAR



Pos	Detaljnr.	Benämning	Passar till	Anm.
1	1134-9027-02	Spännrulle	Park, Villa, Garden, Scoop, Primo	
2	1134-6329-01	Spännrulle	Villa, Ready	
3	1134-5048-01	Spännrulle (plåt)	Garden, Scoop	Distans 1134-5047-01 krävs
4	1134-9091-01	Spännrulle	Villa, Ready	Även för 85B, 107M, 110S
5	1134-9090-01	Spännrulle	Villa	
6	1134-3459-01	Spännrulle	Park	
7	1134-4686-01	Spännrulle	Park 92M, 107M, Villa 92M	

Anm. 1134-9027-02 Spännrulle (grå) ersätter 1134-9027-01 Spännrulle (svart). För kilrem mellan maskin och klippaggregat på Ready och Villa rekommenderas plåtspännrulle 1134-6329-01.

SPÄNNRULLAR - REMSKIVOR - FJÄDRAR



Pos	Detaljnr.	Benämning	Passar till	Anm.
1	1134-3663-01	Spännrulle	Park	
2	1134-1849-01	Remskiva-transaxel	Park, Villa, Ready, Garden	Ø = 154 mm
3	1134-3419-01	Remskiva	Park 102M, 121M, Villa 102M	Ø = 142 mm
4	1134-0698-00	Kåpspännrulle	Park 100B, 110 Combi, 125 Combi, Villa 85B	
5	1134-2171-01	Returfjäder-midja	Park	
6	9547-0001-00	Ledlager-midja	Park	
7	1134-1769-03	Centrumremskiva	Park, Villa, Ready	
8	1134-1770-01	Spännrulle	Park, Primo	
9	1134-1322-01	Spännhjulsfjäder	Park, Villa	
10	1134-1322-02	Spännhjulsfjäder	Park	

STYRNING



Pos	Detaljnr.	Benämning	Passar till	Anm.
1	1134-9021-01	Styrwire	Park 2000 (1975-1983)	
1	1134-9022-01	Styrwire	Park 2000, Park 2002 (1984-1989)	
2	1134-9023-01	Styrwire	Villa I	
3	1134-9084-01	Styrwire kpl	Park (1990-)	Sats vä + hö
3	1134-9099-01	Styrwire kpl	Park Compact 4WD	Sats vä + hö
4	1134-9083-01	Styrwire	Villa II m. wirestyrning	
4	1134-9085-01	Styrwire kpl	Villa II m. kedjstyrning	Sats vä + hö
5	1134-9153-01	Styrwire	Ready, Villa (2007-2009)	
5	1134-9154-01	Styrwire	Ready, Villa (2010-)	
6	1134-9025-01	Linhjul	Park, Villa, Ready, Primo	Sats 2 st.
7	1134-2816-01	Kuggghjul	Park m. kedjstyrning	
8	1134-3547-01	Kuggghjul	Park m. kedjstyrning, Villa	
9	1134-3769-01	Styrknopp sats		

KÅPHJUL - SKYDDSRULLAR (KLIPPAGGREGAT)

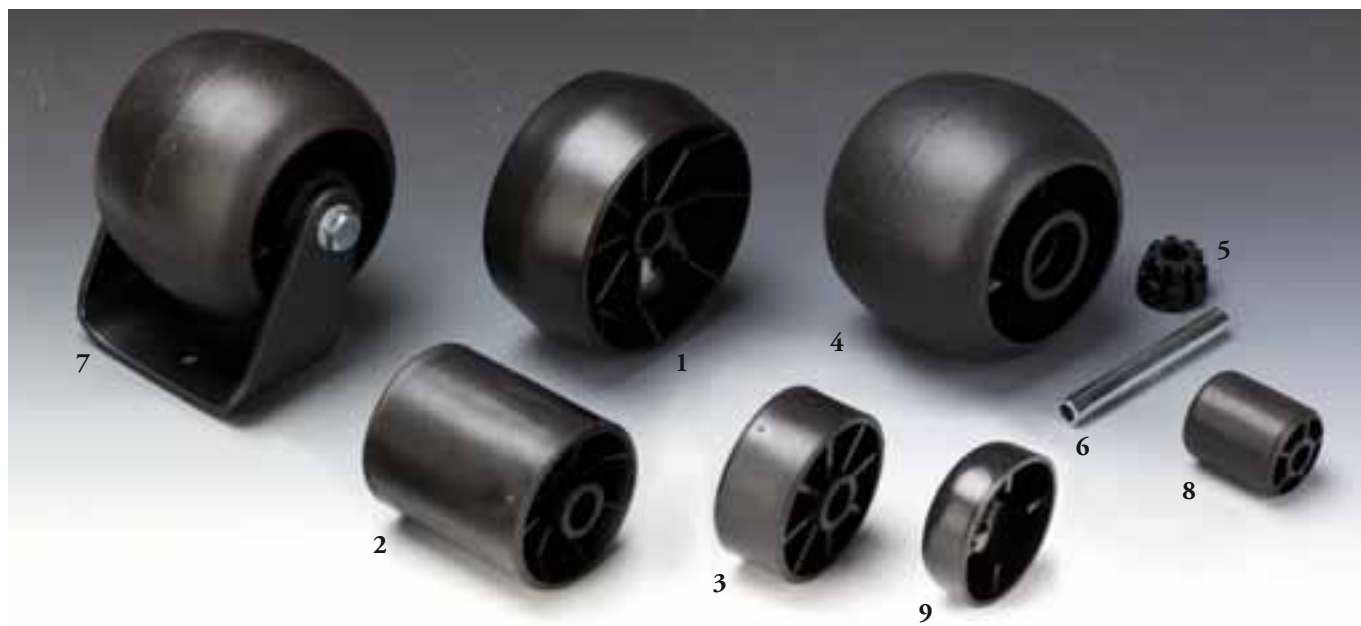

Pos	Detaljnr.	Benämning	Passar till	Anm.
1	1134-2405-01	Kåphjul	Park 100M, 102M, 121M, Villa 85M, 102M	
2	1134-2406-01	Skyddsruulle	Park 100M, 102M, 121M, Villa 85M, 102M	
3	1134-3434-01	Skyddsruulle	Park 100M, 102M, 107M, 121M, 125 Combi	
4	1134-4284-01	Kåphjul	Park 92M, 107M, 125 Combi, Villa 92M, 107M, 85, 95, 105 Combi	
5	1134-4319-01	Lager	Park 92M, 107M, 125 Combi, Villa 92M, 107M, 85, 95, 105 Combi	
6	1134-4318-01	Hylsa	Park 92M, 107M, 125 Combi, Villa 92M, 107M, 85, 95, 105 Combi	
7	1134-5884-01	Pivohjul kpl	Park 110 Combi, 125 Combi, 107M HD	
8	1134-9126-01	Stödrullar	85, 95, 105 Combi	Sats 2 st.
9	1134-1630-01	Skyddsruulle	Villa 85B	

REDSKAPSLYFT - KLIPPAGGREGAT



Pos	Detaljnr.	Benämning	Passar till	Anm.
1	1134-2535-01	Lyftfjäder	Park 100B, 100M, 102M, 107M, 121M	
2	1134-4688-02	Sats-lyftfjäder	Park 92M, 107M, 121M, Villa 107M	
3	1134-5215-01	Höjdställningsspak	85M, 92M, 107M, 121M	
4	1134-3051-01	Spärrknapp d:o		
5	1134-6365-02	Lyftfjäder	Park 110C, 125C	L = 237 mm
5	1134-6365-03	Lyftfjäder	Park 95C, 105C, Villa 105C	L = 222 mm
6	1134-5528-01	Karbinhake		
7	1134-2629-01	Schackel		
8	1134-6182-01	Hankontakt		
ej ill	1134-2314-01	Lyftwire	Park 100B	L = 262 mm
ej ill	1134-2314-02	Lyftwire	Park 100M, 102M, 107M, 121M	L = 302 mm
ej ill	1134-2314-03	Lyftwire	Villa 102M	L = 232 mm

DRIVREMMAR

MOTOR - VÄXELLÅDA/TRANSAXEL/HYDROSTAT

Detaljnr.	Passar till	Innehåller
1134-9008-01	Park 2000, Villa I, Pony	9585-0050-00
1134-9013-01	Park 2002, Park 12 (ej HST), Park Compact, Garden, Scoop	9585-0057-00
1134-9018-01	Garden 6, Garden 8	9585-0120-00
1134-9029-01	Park HST, Park Diesel, Park Pro 16, 18, 20, Park slagklippare	9585-0055-00
1134-9035-01	Park 10, 11, 12, Park Classic	9585-0078-00
1134-9036-01	Park 13HST, President HST, Park Millenium	9585-0083-00
1134-9037-01	Park Pro 16, Park Pro 18	9585-0084-00
1134-9055-01	Villa I President HST, Park President, Millenium	9585-0089-00
1134-9057-01	Park Senator	9585-0093-01
1134-9058-01	Park President, Park Power, Park Comfort, Park Royal, Park Excellent, Park Farmer, Park Compact HST, Park Jubilee, Park Pro 4WD	9585-0091-01
1134-9064-01	Villa Royal, Villa President, Villa Prestige, Villa Elegance, Villa Excellence, Ready HST	9585-0099-01
1134-9065-01	Villa Master, Villa Senator, Villa Comfort, Ready	9585-0124-01
1134-9134-01	Primo	9585-0174-01

MOTOR - KRAFTUTTAG

Detaljnr.	Passar till	Innehåller
1134-9012-01	Park 2002, 10, 11, 12, 13, 16, Park Classic, Millenium, Park Senator, Park President, Park Pro 16, Park Royal	9585-0056-00
1134-9014-01	Park 2002 Diesel, Villa sop	9585-0058-00
1134-9019-01	Park 2000	9585-0100-00
1134-9047-01	Park 18HST, Park Pro 18-20, Park Pro Diesel	9585-0088-00
1134-9066-01	Villa	9585-0125-00
1134-9071-01	Park Senator, Park President, Park Royal, Park Pro 16, Park Comfort, Park Compact, Park Excellent, Park Farmer, Park Jubilee	9585-0129-00
1134-9078-01	Park Slagklippare/Mossrivare	9585-0138-00
1134-9079-01	Villa Master, Villa President, Villa Comfort, Ready	9585-0139-00
1134-9089-01	Villa I Classic, Park 2000	9585-0141-01
1134-9097-01	Park Prestige 4WD, Pro 4WD	9585-0147-01
1134-9098-01	Park Prestige 4WD, Pro 4WD, Park Compact 4WD, Diesel	9585-0148-01
1134-9135-01	Primo	9585-0188-01
1134-9146-01	Ready, Villa (Kevlar rem)	9585-0204-01

KRAFTUTTAG - AGGREGAT

Detaljnr.	Passar till	Innehåller
1134-9009-01	Villa I 85B	9585-0052-00
1134-9011-01	Park 100B	9585-0054-00
1134-9015-01	Park 100M	9585-0061-00
1134-9016-01	Park 110S, 122B	9585-0066-00
1134-9017-01	Garden 6, 8	9585-0119-00
1134-9020-01	Park 2000	9585-0103-00
1134-9031-01	Villa I 85M, 102M, uppt.sop	9585-0072-00
1134-9032-01	Garden 65S, Scoop	9585-0075-00
1134-9033-01	Garden 65B, Scoop	9585-0076-00
1134-9034-01	Park 107M HD (2WD)	9585-0073-00
1134-9041-01	Park sop (2WD)	9585-0067-01
1134-9042-01	Villa sop	9585-0068-01
1134-9043-01	Park upptagande sop (2WD)	9585-0070-01
1134-9044-01	Park snöslunga	9585-0079-01
1134-9045-01	Park 102M, 107M, 121M	9585-0081-01
1134-9048-01	Garden 72S, 72M	9585-0122-00
1134-9049-01	Pony 8, 10	9585-0109-00
1134-9056-01	Park slagklippare	9585-0123-00



DRIVREMMAR

KRAFTUTTAG - AGGREGAT (FORTS.)

Detaljnr.	Passar till	Innehåller
1134-9067-01	Park 107M (2WD)	9585-0126-00
1134-9068-01	Villa II 107M, Villa 95C	9585-0127-00
1134-9069-01	Villa 92M, Ready 92M	9585-0128-00
1134-9075-01	Park 92M (2WD)	9585-0130-00
1134-9076-01	Villa 85M, Ready 85M	9585-0134-00
1134-9100-01	Park 107M (4WD) (kevlar)	9585-0158-00
1134-9101-01	Park 107M HD, sop (4WD) (kevlar)	9585-0155-00
1134-9102-01	Park 121M (4WD), Villa 105C (kevlar)	9585-0157-00
1134-9103-01	Park 125 Combi (4WD) (kevlar) snösl	9585-0156-01
1134-9096-01	Park snöslunga, slagkl. (4WD)	9585-0149-01
1134-9108-01	Park 110 Combi (4WD) (kevlar)	9585-0159-01
1134-9106-01	Park 92M (4WD), Villa 85C	9585-0154-01
1134-9109-01	Park 92M (4WD), Villa 85C (kevlar)	9585-0160-01
1134-9136-01	Primo	9585-0176-01
1134-9147-01	Park 95 Combi (4WD)	9585-0197-01
1134-9148-01	Park 95 Combi (2WD)	9585-0198-01
1134-9149-01	Park 105 Combi (4WD)	9585-0199-01
1134-9150-01	Park 105 Combi (2WD)	9585-0200-01
1134-9151-01	Park 110 Combi (2WD)	9585-0201-01
1134-9152-01	Park 125 Combi (2WD)	9585-0202-01
1134-9156-01	Park 100 Combi 3 (2WD)	9585-0205-01
1134-9157-01	Park 100 Combi 3 (4WD)	9585-0206-01



KLIPPAGGREGAT

Detaljnr.	Passar till	Innehåller	Detaljnr.	Passar till
1134-9004-01	Pony 6S, Pony 8S	9585-0101-00	9585-0095-01	Villa II 92M, Ready 92M
1134-9005-01	Park 110S	9585-0106-00	9585-0096-01	Villa II 107M
1134-9006-01	Park 100B, 100M	9585-0108-00	9585-0107-00	Pony 8, 10
1134-9007-01	Villa I 85B	9585-0118-00	9585-0131-01	Park 92M
1134-9030-01	Villa I 85M	9585-0071-00	9585-0132-01	Park 107M, 107M HD
1134-9034-01	Park 122B	9585-0073-00	9585-0133-01	Villa II 107M
1134-9041-01	Park 110 Combi Pro	9585-0067-00	9585-0135-01	Villa II 85M, Ready 85M
1134-9087-01	Park 125 Combi Pro	9585-0142-00	9585-0161-01	Villa 85 Combi
1134-9133-01	Primo	9585-0173-01	9585-0162-01	Villa 95 Combi
9585-0085-00	Park 121M		9585-0163-01	Villa 105 Combi
9585-0087-00	Park 102M, Villa 102M		9585-0164-01	Park 95 Combi
9585-0092-01	Park 107M		9585-0165-01	Park 105 Combi

DRIVREMMAR FÖR GARDEN OCH ESTATE

Detaljnr.	Passar till	Innehåller	Detaljnr.	Passar till
1134-9161-01	Estate Basic, Tornado (motor-vxl.låda) (-2007)	35062000/1	35061980/0	Estate Tornado HST (motor-vxl.låda) (-2007)
1134-9160-01	Estate Basic, Tornado (aggregat)	35061503/0	35062012/0	Estate Basic, Tornado (2008-), Estate Collector, Senator (2007-)/Senator 14 (2011-), SC 9214 (2011-); ST 10216 H (2011-) (motor-vxl.låda)
135061427/0	Garden Compact EV (Variator), SR 6365 EV (2011-)		35062001/0	Estate Tornado HST (2008-), Estate President (2007-), Estate Senator HST 17/Pro HST 17 (2011-), Baron, Royal/Royal 19 (2011-)/Royal Pro 17 (2011-)/Grand Royal 22 (2011-), Pro (motor-vxl.låda)
119700062/0	Garden Compact EV (Variator), SR 6365 EV (2011-)		35065701/0	Estate Collector/Senator/President (2007-)/Senator 14/Senator HST 17/Pro HST 17 (2011-); SC 9214(2011-) (aggr.)
135062013/0	Estate Tornado (2009-); Estate Tornado 14/Grand Tornado 17 (2011-); SD 9812/10816 (2011-) (motor-vxl.låda)		35065600/0	Estate Baron - Royal/Royal 19/Pro 17; Pro 20; Overland 22 4WD (2011-); ST 10216H (2011-) (aggregat, kuggrem)
135061504/0	Estate Tornado (2009-)/Tornado 14/HST 17/Pro HST 13 (2011-); SD 9812/9814 H (2011-) (motor-aggregat)		35065601/0	Estate Pro 25/Gran Royal 22 (2011-), Overland/Grand Overland 24 E/24 4WD/Pro 25 4WD E (2011-) (aggregat, kuggrem)
135062002/1	Estate Pro 2WD (2009-), Overland 4WD (2009-); Overland 22 4WD (2011-); Grand Overland 24E/24 4WD/Pro 25 4WD W (2011-) (motor-vxl.låda)		35062811/0	Estate Baron - Royal/Royal 19 (2011-)/Royal Pro 17 (2011-); ST 10216 H (2011-) Pro 20 - Overland; Overland 22 4WD (2011-) (aggr.)
135062003/0	SD 9814 H; Estate Tornado HST 17/Pro HST 13/Grand Tornado HST 19/Grand Tornado Pro HST 17 (2011-)		35062812/0	Estate Pro 25, Grand Royal 22 (2011-); Overland, Grand Overland 24E/24 4WD/Pro 25 4WD E (2011-) (aggregat)
35061406/0	Garden Compact		135061506/0	SD 10816 (2011-); Estate Grand Tornado 17/HST 19/Pro HST 17 (2011-)
35061400/0	Garden Combi (motor-vxl.låda)			
35061404/0	Garden Combi HST (motor-vxl.låda)			
35061423/0	Garden Combi, Garden Combi HST 14/Pro HST 13 (2011-) (aggregat)			

STARTBATTERIER



Pos	Detaljnr.	Benämning	Passar till	Anm.
1	1134-6677-01	Batteri (16 Ah)	Primo	L=180 B=75 H=165
2	1134-4804-01	Batteri (18 Ah)	Park, Ready, Villa, Garden, Estate	L=180 B=75 H=167
ej ill	82180050/0	Laddare d:o		600 mA, EU-kontakt
ej ill	82180052/0	Laddare d:o		600 mA, UK-kontakt
3	9400-0086-00	Batteri (18 Ah)	Park, Villa, Garden	L=200 B=88 H=164
4	1134-2892-01	Batteri (24 Ah)	Park, Tractor 12/39 4WS	L=180 B=122 H=175
5	1134-5751-01	Batteri (24 Ah)	Park 4WD	L=194 B=128 H=155
6	1134-4940-02	Batteri (40 Ah)	Park Pro Diesel	L=195 B=125 H=200
7	18120004/0	Batteri (7,2 Ah)	Garden Compact E	L=150 B=65 H=95
ej ill	82180051/0	Laddare d:o		200 mA, EU-kontakt
ej ill	82180053/0	Laddare d:o		200 mA, EU-kontakt

ELSYSTEM

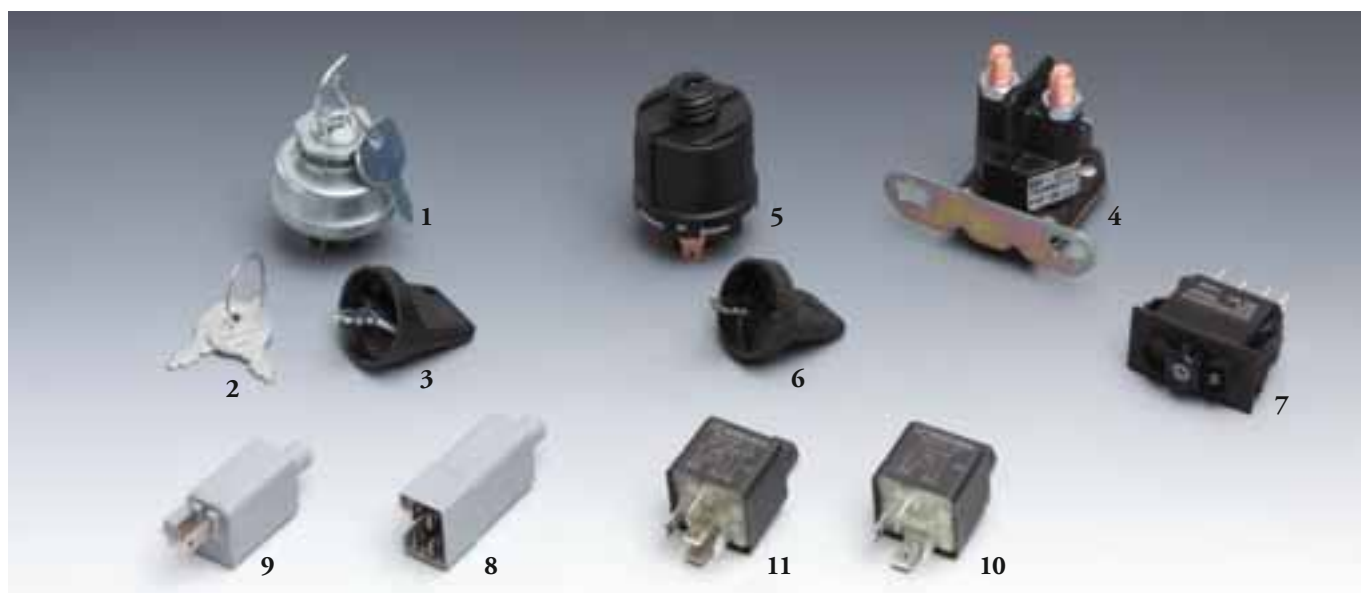

Pos	Detaljnr.	Benämning	Passar till	Anm.
1	1134-1814-01	Tändningslås	Park, Villa, Garden, Scoop ES	Inkl. tändningsnyckel
2	1134-2848-01	Tändningsnyckel d:o	Passar även Estate	Säljs parvis
3	1134-3368-01	Tändningsnyckel d:o		1-styck
4	1134-2962-01	Solenoid		
5	1134-4093-01	Tändningslås	Park, Villa, Ready, Primo	Utan tändningsnyckel
6	1134-4734-01	Tändningsnyckel d:o		
7	9400-0282-01	Brytare	Park, Villa	
7	9400-0283-01	Brytare	Park Pro 20, Pro Diesel	
8	1134-3399-01	Brytare	Park, Villa	
9	1134-3399-02	Brytare	Park, Villa, Ready, Garden	
10	1134-2871-01	Relä	Park	4 anslutningar
11	1134-2871-03	Relä	Park, Villa, Primo	5 anslutningar

ÖVRIGT (ÅKGRÄSKLIPPARE)



Pos	Detaljnr.	Benämning	Passar till	Anm.
1	1134-7465-01	Snabbfästen	Park med RAC-system	Sats 2 st.
2	1134-6340-02	Fotstöd	Park drivpedal	
3	1811-9013-02	Brytbult	Park snöslunga 2-steg	Sats 2 st.
4	1139-1080-01	Tätningring-hjulaxel	K46, K574	Ø 19 mm
5	1139-1414-01	Bussning d:o	K46, K574	
6	1139-1044-01	Tätningring-hjulaxel	KTM10, K62	Ø 25,4 mm
7	1139-1415-01	Bussning d:o	KTM10, K62	
8	1319-1721-01	Slaga	Park slagklippare	1-styck
8	1319-1772-01	Slaga	Park slagklippare	Sats 104 st.

ÖVRIGT (ÅKGRÄSKLIPPARE)



Pos	Detaljnr.	Benämning	Passar till	Anm.
1	1134-4109-01	Oljefilter	Park Pro 20, Pro Diesel	
2	1134-5962-01	Oljefilter (metall)	Park 4WD (2005-2006)	
3	1134-5962-02	Oljefilter (papper)	Park Pro 4WD (2007-)	
4	1139-1186-01	Oljefilter	Park Pro 20, Pro Diesel	
5	1134-9024-01	Plastlager	Park, Villa, Garden, Primo	Sats 4 st.
6	1134-9026-01	Oljebrons-lager	Park, Villa	Sats 4 st.
7	1134-9028-01	Gummistropp	Park, Villa	Sats 4 st.
8	1134-4904-01	Huvlås	Villa	
9	1134-5532-01	Tanklock	Park, Villa, Ready, Primo	
10	1134-4064-01	Tanklock m.mätare	Park	
11	1134-3224-01	Bensinkran	Park, Villa, Ready, Scoop, Garden	
12	1134-3225-01	Gummibussning d:o		

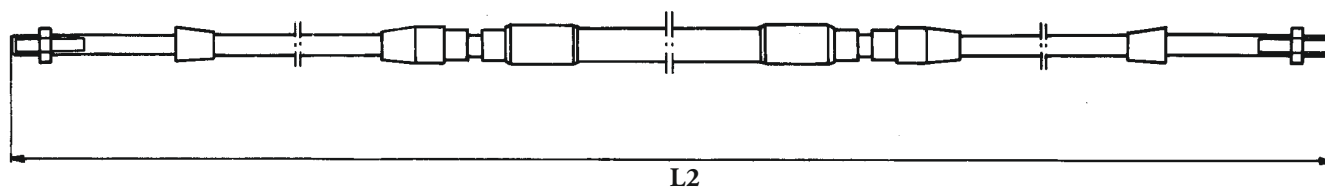

Detaljnr.	Benämning	Passar till	Anm. (mm)
1134-0280-00	Växelwire	Park 2000 (1974-1984)	L2= 896

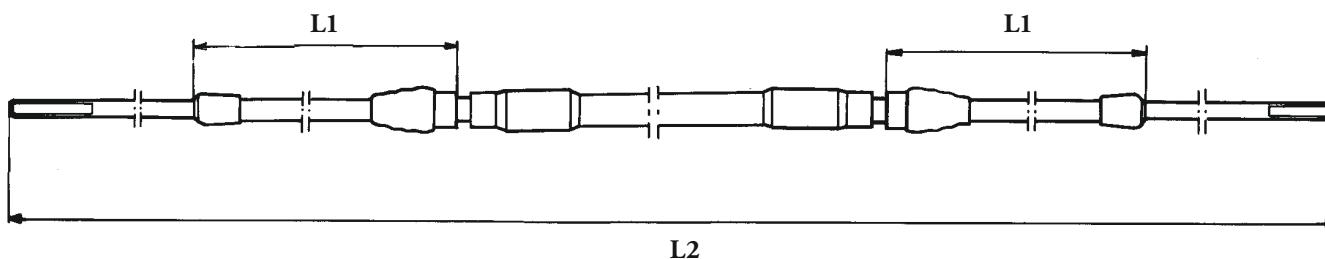

Detaljnr.	Benämning	Passar till	Anm. (mm)
1134-2031-02	Växelwire	Park (1985-1999)	L1= 160/134 - L2= 1337

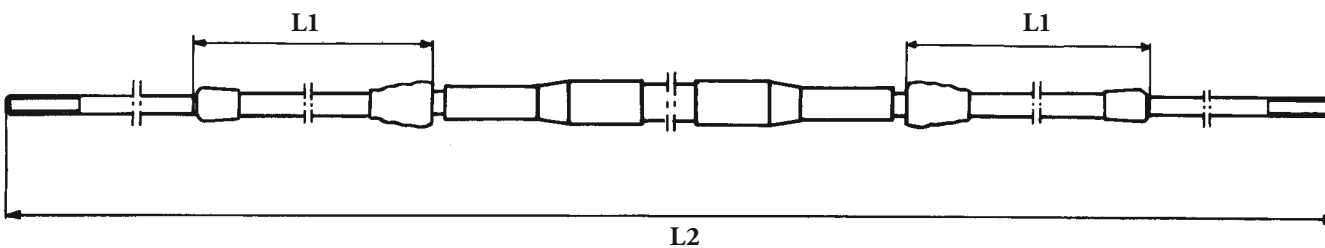

Detaljnr.	Benämning	Passar till	Anm. (mm)
1134-2766-01	Reglagewirar	Park 12HST, 16HST (-1993)	L1= 160/134 - L2= 1258
1134-2766-02	Reglagewirar	Park Pro 16, 18 (1994-1999)	L1= 110/134 - L2= 1229
1134-2766-03	Reglagewirar	Park 13HST, President (1994-1999)	L1= 160/134 - L2= 1304
1134-2766-04	Reglagewirar	Park Pro 16, 18, 20 (2000-2005)	L1= 134/134 - L2= 1310
1134-2766-05	Reglagewirar	Park President, Royal, Compact HST (2000-)	L1= 160/134 - L2= 1250
1134-2766-06	Reglagewirar	Park Senator (2000-2003)	L1= 160/134 - L2= 1420
1134-2766-07	Reglagewirar	Park Compact (2004-)	L1= 258/134 - L2= 1489
1134-2766-08	Reglagewirar	Park Pro 4WD (2005-)	L1= 100/134 - L2= 960

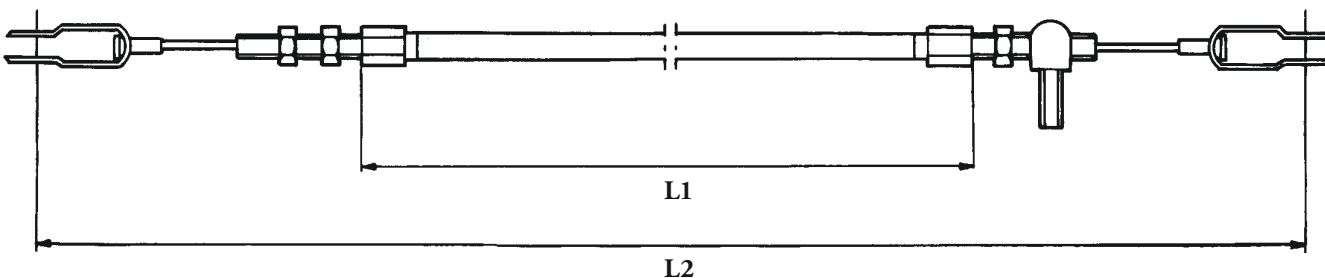

Detaljnr.	Benämning	Passar till	Anm. (mm)
1134-0226-00	Kopplingswire	Park 2000 (1975-1984)	L1= 1086 - L2= 1350

REGLAGEWIRAR

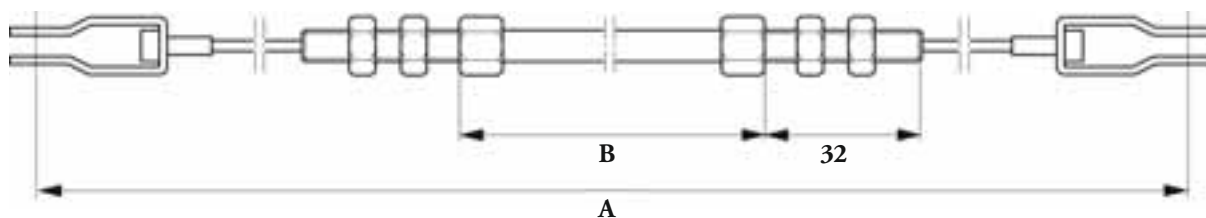

Detaljnr.	Benämning	Passar till	Anm. (mm)
1134-2030-04	Kopplingswire	Park 2000 (1985-1999)	A= 788 - B= 540
1134-2030-08	Kopplingswire	Park 2002 Diesel (1986-1988)	A= 812 - B= 519
1134-2030-10	Kopplingswire	Park HST (1989-1993)	A= 1136 - B= 955
1134-2030-11	Kopplingswire	Park 13HST, President (1995-1999)	A= 808 - B= 540

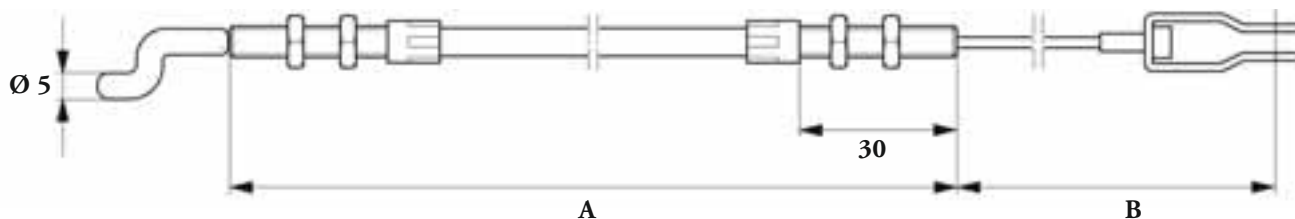

Detaljnr.	Benämning	Passar till	Anm. (mm)
1134-4058-01	Reglawire	Park Senator (2000-03), Park Compact (2004-)	A= 680 - B= 150

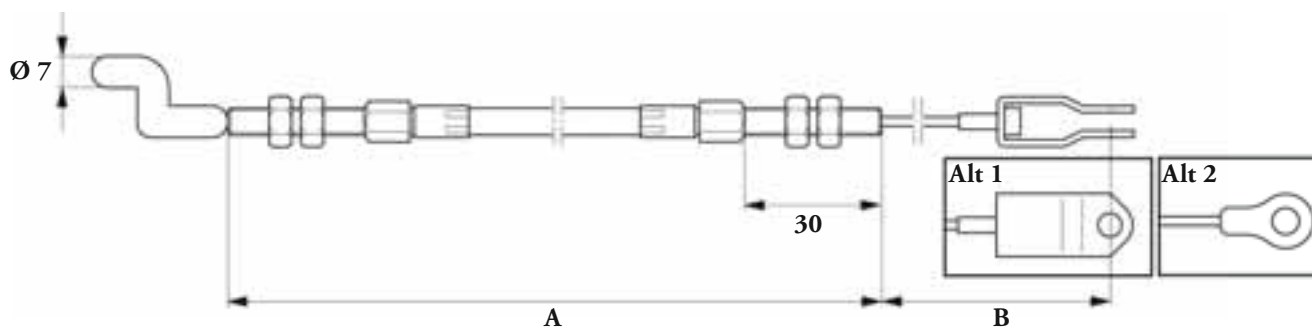

Detaljnr.	Benämning	Passar till	Anm. (mm)
1134-3573-01	Kraftuttagwire	Park (1985-1999)	A= 315 - B= 146
1134-3573-02	Bromswire	Park (1989-1999), President (1995-1999)	A= 884 - B= 179
1134-3573-03	Kraftuttagwire	Park (2000-)	A= 804 - B= 126
1134-3573-04	Kraftuttagwire	Villa II (2003-2006)	A= 427 - B= 123
1134-3573-05	Kraftuttagwire	Park Compact (2004-)	A= 395 - B= 110
1134-3573-06	Kraftuttagwire	Ready (2004-), Villa (2007-)	A= 460 - B= 172

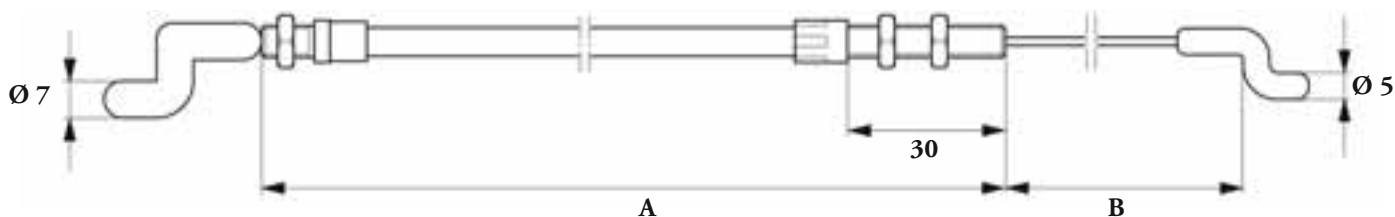

Detaljnr.	Benämning	Passar till	Anm. (mm)
1134-6005-01	Reglawire	Park Compact 4WD (2006-), Prestige (2006-)	A= 755 - B= 280

REGLAGEWIRAR

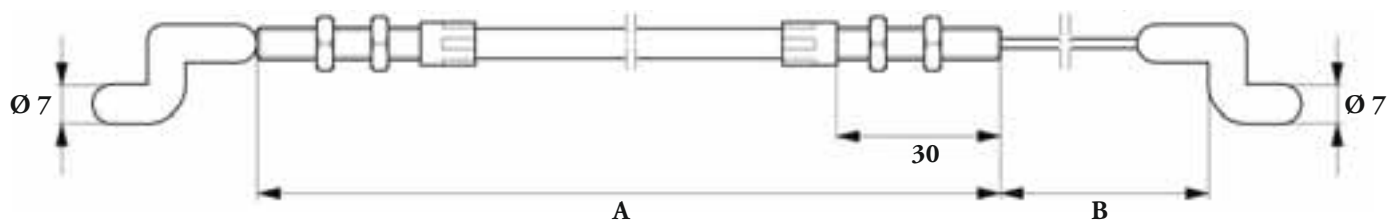

Detaljnr.	Benämning	Passar till	Anm. (mm)
1134-5815-01	Reglagewire	Park Pro (2005-)	A= 1100 - B= 255

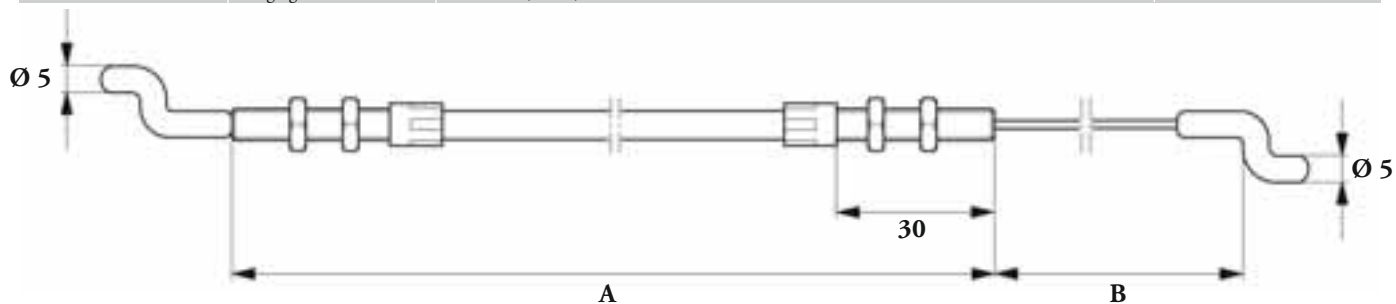

Detaljnr.	Benämning	Passar till	Anm. (mm)
1134-3584-01	Reglagewire	Park 16HST, 18HST (1994-1999)	A= 800 - B= 200
1134-3584-02	Reglagewire	Park Pro 16, 18, 20 (2000-2005)	A= 840 - B= 150
1134-3584-03	Reglagewire	Park President, Comfort, Royal och utförligare (2000-)	A= 775 - B= 171

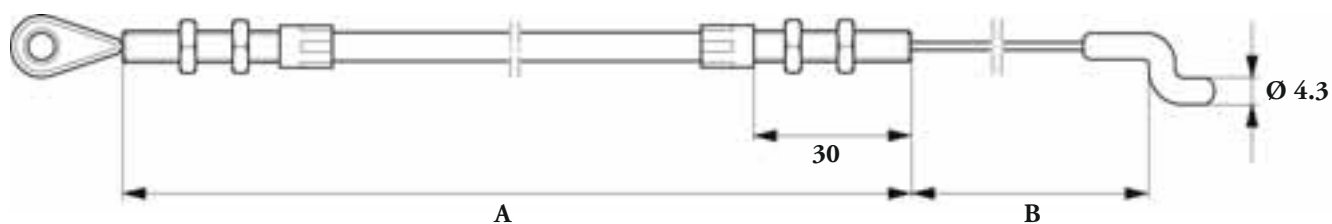

Detaljnr.	Benämning	Passar till	Anm. (mm)
1134-3410-02	Bromswire	Park (1994-1999), Park Senator, Compact	A= 878 - B= 170

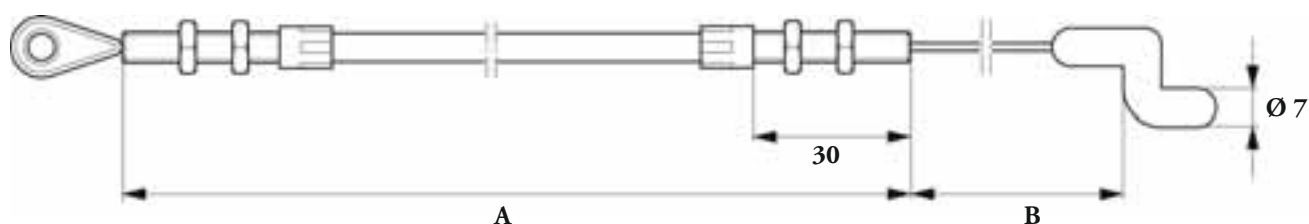

Detaljnr.	Benämning	Passar till	Anm. (mm)
1134-4006-01	Reglagewire	Park Pro 16, 18, 20 (2000-2005)	A= 1130 - B= 135

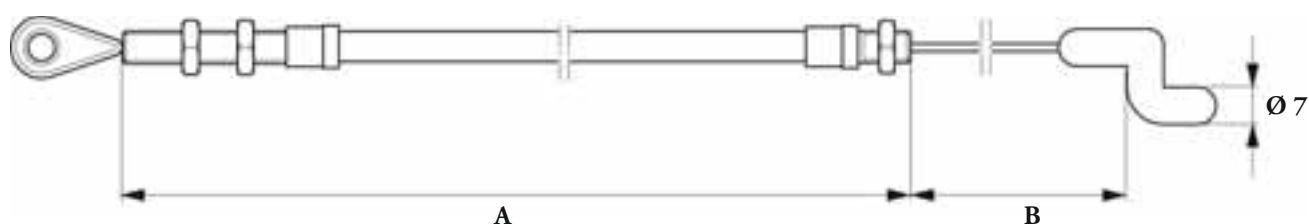

Detaljnr.	Benämning	Passar till	Anm. (mm)
1134-6020-01	Bromswire	Park Pro 4WD (2006-)	A= 670 - B= 268

GAS-, CHOKEREGGLAGE

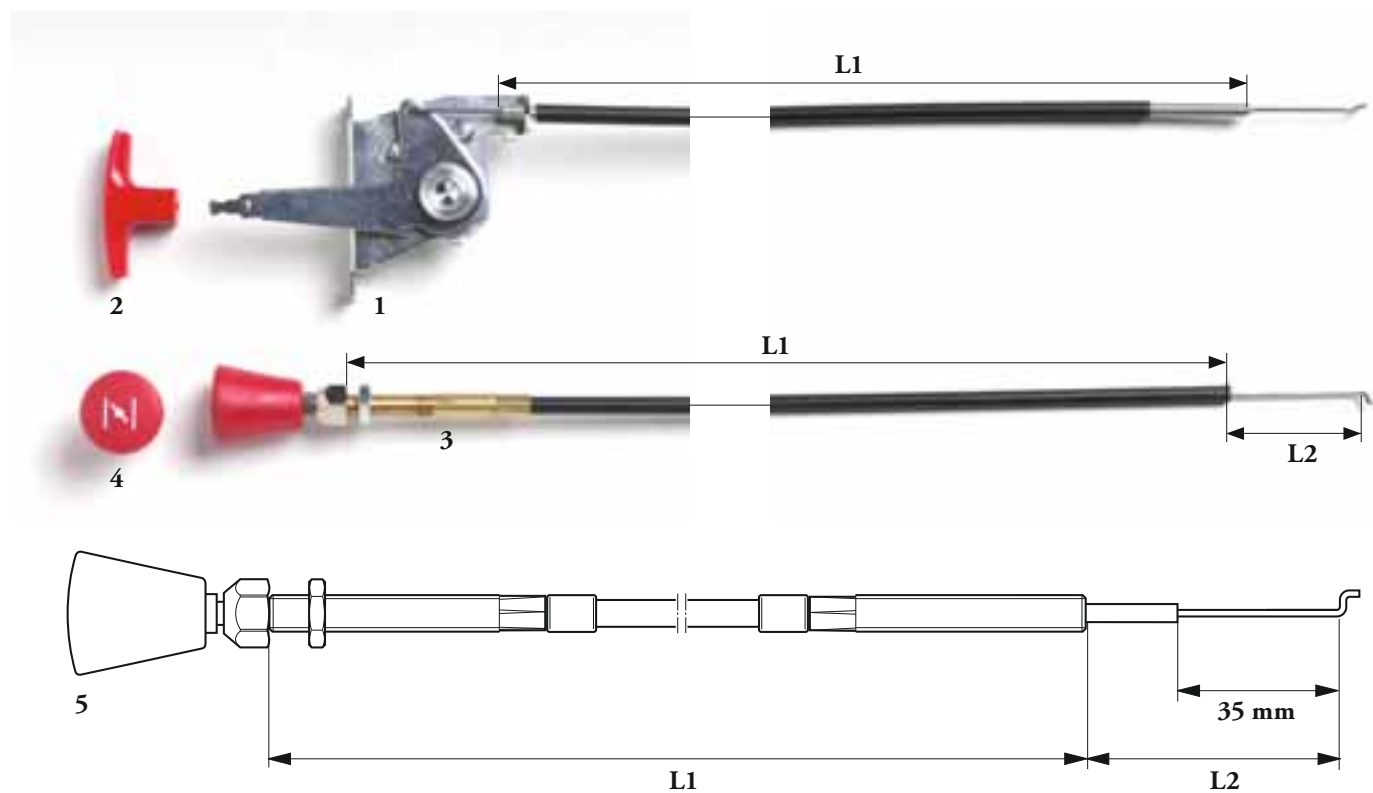

Pos	Detaljnr.	Benämning	Passar till	Anm. (mm)
1	1134-1975-01	Gasreglage	Villa I (-2003)	L1= 520
1	1134-1975-03	Gasreglage	Park 2000, Park 2002 (1984-1985)	L1= 1430
1	1134-1975-05	Gasreglage	Garden 6 (1984-1992)	L1= 376
1	1134-1975-09	Gasreglage	Park 2002, 12 (1986-1991)	L1= 1302
1	1134-1975-11	Gasreglage	Park 10, 11, 12, 13 (1992-1999)	L1= 1250
1	1134-1975-12	Gasreglage	Park 16, 18 (1998-1999)	L1= 1690
2	9403-0035-10	Knopp D:o	Medföljer ej gasreglaget	
3	1134-2872-01	Chokereglage	Park (1990-1999), Park (2005-)	L1= 1768 - L2= 42
3	1134-2872-02	Chokereglage	Park Pro 16, 18, 20 (2000-)	L1= 1405 - L2= 55
3	1134-2872-03	Chokereglage	Park Royal, Power (2000-)	L1= 1509 - L2= 46
3	1134-2872-04	Chokereglage	Villa Royal (2003-06)	L1= 952 - L2= 46
3	1134-2872-05	Chokereglage	Park Prestige, Power (2006-)	L1= 1100 - L2= 55
4	1134-4338-01	Knopp D:o	Ingår i chokereglaget	
5	1137-0062-01	Chokereglage	Park Pro (2010-)	L1= 1693 - L2= 55
5	1137-0062-02	Chokereglage		L1= 1392 - L2= 68
5	1137-0062-03	Chokereglage	Park Ranger, Royal, Excellent (2011-)	L1= 1496 - L2= 59

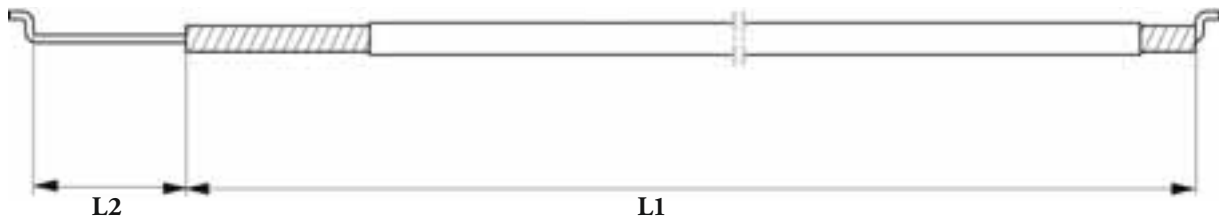

Detaljnr.	Benämning	Passar till	Anm. (mm)
1134-1597-09	Gaswire	Scoop, Garden (1992-2003)	L1= 585 - L2= 73
1134-1597-10	Gaswire		L1= 1430 - L2= 62
1134-1597-11	Gaswire	Villa II w. B&S motor (2001-2006)	L1= 568 - L2= 64
1134-1597-12	Gaswire	Villa II w. Honda motor (2001-2006)	L1= 1106 - L2= 64
1134-1597-13	Gaswire	Ready (2004-), Villa 12 (2007-)	L1= 680 - L2= 64
1134-1597-14	Gaswire	Primo (2008-)	L1= 392 - L2= 50



Detaljnr.	Benämning	Passar till	Anm. (mm)
1134-4197-01	Gaswire	Park President, Comfort (2004-)	L1= 925 - L2= 62
1134-4197-02	Gaswire	Park Compact (2004-2006)	L1= 1300 - L2= 62
1134-4197-03	Gaswire	Villa (2007-), Park Compact (2007-)	L1= 1350 - L2= 62
1134-4197-04	Gaswire	Park Compact WM14 (2007)	L1= 1350 - L2= 62
1134-4197-05	Gaswire	Villa Silent (2009-)	L1= 1400 - L2= 62

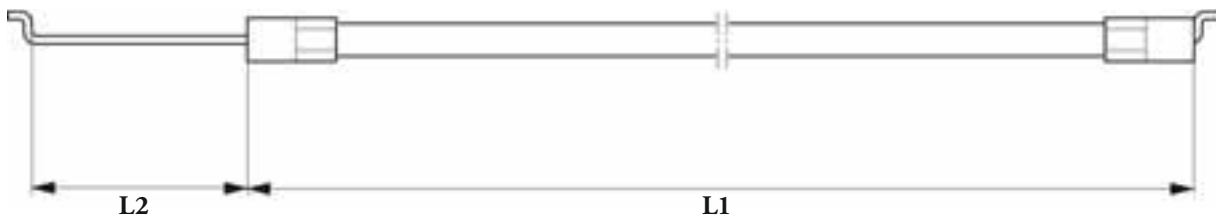

Detaljnr.	Benämning	Passar till	Anm. (mm)
1134-4195-01	Gaswire	Park Pro 16, 18, 20 (2000-)	L1= 1413 - L2= 60
1134-4195-02	Gaswire	Park Royal m.fl. (2000-)	L1= 1390 - L2= 65
1134-4195-03	Gaswire	Park Pro (2005-)	L1= 1713 - L2= 60
1134-4195-04	Gaswire	Park Prestige, Power (2006-)	L1= 1070 - L2= 60

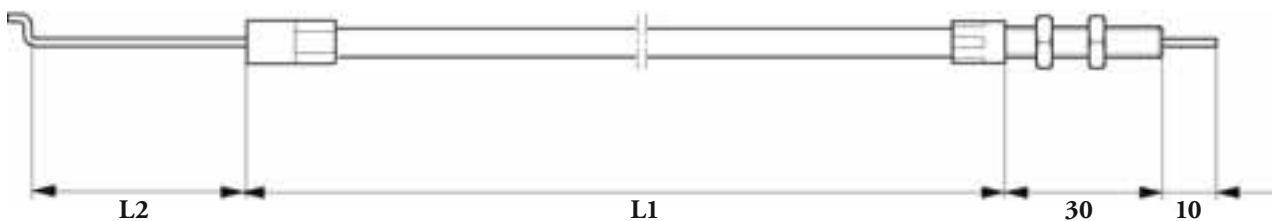

Detaljnr.	Benämning	Passar till	Anm. (mm)
1134-4923-01	Gaswire	Park Diesel (2002-)	L1= 880 - L2= 110

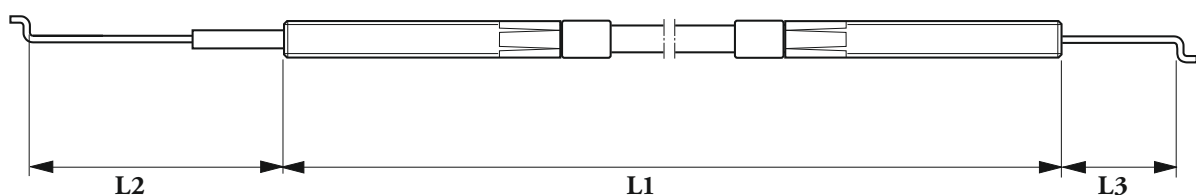

Detaljnr.	Benämning	Passar till	Anm. (mm)
1137-0063-01	Gaswire	Park Pro (2010-)	L1= 1693 - L2= 55 - L3= 25
1137-0063-02	Gaswire	Park Residence, Plus, Prestige (2011-)	L1= 925 - L2= 50 - L3= 20
1137-0063-03	Gaswire	Park Ranger, Royal, Excellent (2011-)	L1= 1413 - L2= 55 - L3= 25

MOTORER (GGP)



Pos	Detaljnr.	Benämning	Modell	Typ	Cylindervolym (cc)	Anm.
	118550407/0	Motor kpl	SA 45	OHV	140	
	118550157/1	Motor kpl	RM 45	SV	150	
	118550370/0	Motor kpl	SV 150-T	SV	150	För jordfräs
	318550350/0	Motor kpl	M 150 Ethanol	SV	150	
1	118550408/0	Motor kpl	SA 55	OHV	160	
	118550411/0	Motor kpl	SA 55 ES	OHV	160	Med elstart
	118550409/0	Motor kpl	SA 55-T	OHV	160	För jordfräs
	118550410/0	Motor kpl	SA 55	OHV	160	För Silent
	118550318/0	Motor kpl	SA 65	OHV	196	
	118550431/0	Motor kpl	SA 65 E	OHV	196	Med elstart
	118550439/0	Motor kpl	WM 12,5	OHV	414	
	118550451/0	Motor kpl	WM 14	OHV	432	
2	118550526/0	Motor kpl	WM 16	OHV	452	
3	1111-9159-01	Servicesats	För GGP-motor 150 cc (V35, SV40)			Olja, tändstift, luftfilter
4	1111-9172-01	Servicesats	För GGP-motor 140/160/196 cc			Olja, tändstift, luftfilter

FILTER (GGP-MOTORER)

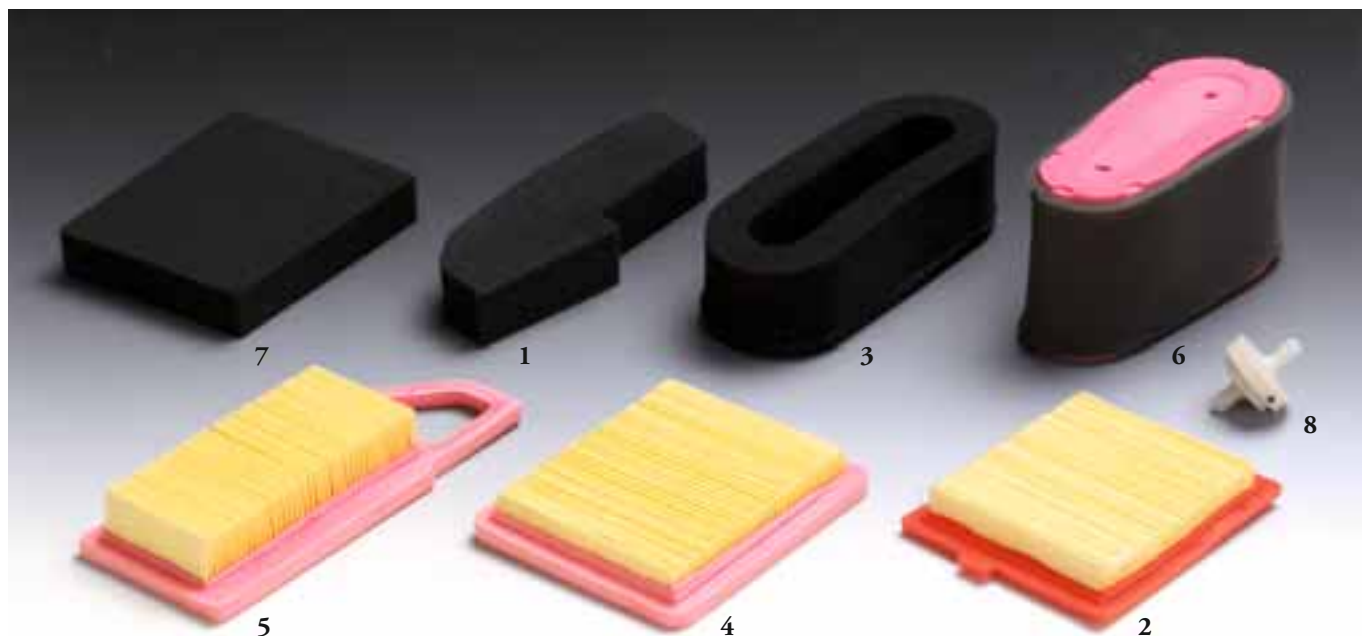

Pos	Detaljnr.	Benämning	Passar till	Innehåller
1	1111-9152-01	Luftfilter	V 35, SV 40, RV 45, RM 45	18550011/0
2	1111-9169-01	Luftfilter	RM 45 (2007-)	18550147/0
3	1111-9170-01	Luftfilter	OM 65, RM 65 (2007-)	18550187/0
4	1111-9204-01	Luftfilter	OM 55, RM 55, SA 55, SA 65 (160+196 cc)	118550257/0
5	1134-9163-01	Luftfilter	WM 12,5	118550321/0
6	1134-9162-01	Luftfilter	WM 13,5, WM 14,5, WM 16	118550199/0
7	1111-9205-01	Luftfilter	SA 45 (140 cc)	118550452/0
8	118550354/1	Bränslefilter		

TÄNDSTIFT (CHAMPION)

Detaljnr.	Beteckning	Passar till
9400-0225-00	J19LM	De flesta motorgräsklippare, GGP-motor V35, SV40, RM45
1111-9028-02	J19LM	De flesta motorgräsklippare, GGP-motor V35, SV 40, RM45 (Stiga - förpackning)
3210060	RJ19LM	De flesta motorgräsklippare, GGP-motor V35, SV40, RM45 - radioavstört
9400-0289-01	RN9YC	Honda GCV135, GCV160, GGP-motor OM60, RV/RM 65
1111-9154-01	RN9YC	Honda GCV135, GCV160, GGP-motor OM60, RV/RM 65 (Stiga - förpackning)
9400-0303-01	RN11YC4	Honda GCV520, GCV530
9400-0244-00	RC12YC	Park 16/18HST, Park Pro 16, 18, 20, Royal (B&S), Multiclip Pro 51S, GGP WM, GGP OM55
9400-0258-00	CJ7Y	Kedjesåg 955, SP340/370/410/460/510/382/472/522, SPR 270/270C Røjare ST210/26], SB 22/28/26/26JD/29S/29DS/30/40/52/35S/35DS/43S/51DS, SB 34/34D, BJ 32S/32SD/33S/33SD/345D
9400-0278-00	CJ8Y	Jordfräs JB20, JB25 Snöslunga 321, 521, Snow Star, Snow Max
9400-0259-00	DJ6J	
9400-0260-00	DJ7J	
9400-0226-00	DJ7Y	Trimmer 6000, 7000, 8000
9400-0261-00	DJ8J	Kedjesåg 930, 935, 940, Trimmer ST270, ST280, Trimmer ST311, SD31, Røjare Pro 41, 47, SD2500, 3100, 4100
23051000/0	RZ7C	Trimmer 27/29/32/35, Kedjesåg SP 350-352-400-442
1111-9029-01	Tändstiftsnyckel 19/21 mm	
1111-9029-02	Tändstiftsnyckel 5/8" (16 mm)/21 mm	



FRIKTIONSHJUL - BRYTBULTAR (SNÖSLUNGOR)



Pos	Detaljnr.	Benämning	Passar till	Anm.
1	1812-9028-01	Friktionshjul	522 - 825 (1983-1993), samtliga (1994-)	
2	1812-9003-01	Friktionshjul	828 - 1232 (1983-1993)	
3	1812-9005-01	Brytbult	Bl. a. Snow Storm, Snow Blizzard Snow Hurricane, Snow Track, 866, 1174HST, Snow Spark, Flake, Power	Sats 2 st.
4	1812-9006-01	Brytbult	Bl. a. 1384	Sats 2 st.
5	1812-9011-01	Brytbult	Snow Fall (2004-2005)	Sats 2 st.
6	1812-9012-01	Brytbult	Snow Rise (2006-)	Sats 2 st.
7	1812-9029-01	Brytbult	966D, 1171HST, 1381HST (2006-)	Sats 2 st.

DRIVREMMAR (SNÖSLUNGOR)

FRAMDRIVNING

Detaljnr.	Passar till
1812-9008-01	825 (1983-1993)
1812-9009-01	521 (1983-1987), 523 (1988-1994)
1812-9010-01	725T, 825T (1986-1993)
1812-9015-01	828 (1988-1993), 1132 (1983-1987), 1232 (1988-1993)
1812-9016-01	522 (1995-1996), 524 (1994-1999), 725 (1996), Snow Master, Snow Buster, Snow King, Snow Storm, Snow Blizzard, Snow Spark, Snow Hurricane, Snow Track, Snow Unltd, Snow Flake, Snow Power, Snow Super, 827 (1994-1996), 827T (1994-1995), 928 (1997, 2000-02), 928T (2000-02), 1030 (1994-96), 866 (2004-), 1130 (1997), 1384 (2002-), 966D, 1174 Track, 1384D
1812-9024-01	928E, 928ET (1998-1999), 1130E (1998), 1330E (1999), 1333 (2000-2001)
1812-9027-01	1174HST (2002-)

SNÖSKRUV

Detaljnr.	Passar till	Innehåller
1812-9007-01	322 (1983-1993)	
1812-9011-01	521 (1983-1984), 825 (1983-1984)	
1812-9012-01	521 (1985-87), 523 (1988-93), 524 (1994), 725T (1988-93), 827T (1994)	
1812-9013-01	825 (1985-1993), 825T (1986-1993)	
1812-9014-01	828 (1983-1993), 1132 (1983-1987), 1232 (1989-1993)	
1812-9017-01	827 (1994)	
1812-9018-01	1030 (1994-1996), 1130 (1997), 928T (2000)	
1812-9019-01	522 (1995-1996), 524 (1997-1999), Snow Master (2000)	
1812-9020-01	827 (1995-1996), Snow Buster, Snow King, Snow Spark, Snow Storm, Snow Blizzard, Snow Unltd, Snow Hurricane, Snow Track, Snow Flake, Snow Power, Snow Super, 928 (1997, 2000-02), 866 (2004-), 1174HST (2002-), 1384 (2002-), 966D, 1174 Track, 1384D	
1812-9021-01	725 (1996), 827T (1995)	
1812-9022-01	928ET (1998-1999)	
1812-9023-01	928E (1998-1999), 1130E (1998), 1330E (1999), 1333 (2000-2001)	
1812-9025-01	320 (1997), 321 (1998), 521 (1999), Snow Star (1999-), Snow Max (2000-)	
1812-9026-01	Snow Master (2001-2003)	
1811-2135-01	Snow Electr. (2004-2005)	
1811-2307-01	Snow Electr. 1300 (2006-)	
1811-2356-01	Snow Electr. 2000 (2007-)	
1812-1878-01	Snow Breeze (2004-2006), Snow Frost (2007-)	
1812-2012-01	Snow Rex (2005-)	
1811-9014-01	Snow Rise (2006-), Snow Cube (2007-) snöskruv	1811-2409-01
1811-2543-01	Snow Crystal (2007-) snöskruv	
1811-2410-01	Snow Rise (2006-), Snow Cube, Crystal (2007-) framdrivning	
1811-2090-01	Snow Fall (2004-2005) framdrivning	
1811-2091-01	Snow Fall (2004-2005) snöskruv	
1812-2220-01	966D (2006-), Snow Blizzard, Snow Flake, Snow Power, Snow Spark framdrivning	
1812-2219-01	1171 HST, 1381 HST (2006-) framdrivning	
1812-2232-01	966D, 1171 HST, 1381 HST (2006-) snöskruv	

Anm. Dessa kilremmar levereras utan hylsa.





Detaljnr.	Längd	Delning	Bredd	Typ	Passar till
1519-9001-38	38E	3/8"	0.050" (1.3 mm)	91VG	
1519-9001-39	39E	3/8"	0.050" (1.3 mm)	91VG	
4113709	40E	3/8"	0.050" (1.3 mm)	91VG	SPR 270
1519-9001-44	44E	3/8"	0.050" (1.3 mm)	91VG	SPR 350
1519-9001-45	45E	3/8"	0.050" (1.3 mm)	91VG	
1519-9001-46	46E	3/8"	0.050" (1.3 mm)	91VG	
1519-9001-49	49E	3/8"	0.050" (1.3 mm)	91VG	SP 355 (14" svärd), SE 180
1519-9001-50	50E	3/8"	0.050" (1.3 mm)	91VG	SE 1.6, SE 180, SE 190, SP 340, SE 182, SE 192, SE 202, SP 382
1519-9001-52	52E	3/8"	0.050" (1.3 mm)	91VG	SP 352, 1600 (14" svärd)
1519-9001-54	54E	3/8"	0.050" (1.3 mm)	91VG	SP 355 (16" svärd)
1519-9001-55	55E	3/8"	0.050" (1.3 mm)	91VG	
1519-9001-56	56E	3/8"	0.050" (1.3 mm)	91VG	SE 1.8, SE 200Q, SE 202, SP 352, 1600, SP 382 (16" svärd)
1519-9001-57	57E	3/8"	0.050" (1.3 mm)	91VG	SP 338, Pro 1800
1519-9001-60	60E	3/8"	0.050" (1.3 mm)	91VG	
1519-9002-56	56E	0.325"	0.050" (1.3 mm)	95VP	SP 370, SP 410, SP 440, SP 480
1519-9002-64	64E	0.325"	0.050" (1.3 mm)	95VP	SP 410
1519-9002-66	66E	0.325"	0.050" (1.3 mm)	95VP	SP 420, SP 440, SP 442, SP 462, SP 472, SP 480,
1519-9002-72	72E	0.325"	0.050" (1.3 mm)	95VP	SP 442, SP 480, SP 482
1519-9003-56	56E	0.325"	0.058" (1.5 mm)	21BP	SP 460, SP 462, SP 510, SP 522, SP 480, SP 482
1519-9003-61	61E	0.325"	0.058" (1.5 mm)	21BP	
1519-9003-64	64E	0.325"	0.058" (1.5 mm)	21BP	
1519-9003-66	66E	0.325"	0.058" (1.5 mm)	21BP	SP 460, SP 510, SP 522
1519-9003-72	72E	0.325"	0.058" (1.5 mm)	21BP	SP 510, SP 522
4113723	78E	0.325"	0.058" (1.5 mm)	21BP	
1519-9004-56	56E	3/8"	0.058" (1.5 mm)	73LP	
1519-9004-60	60E	3/8"	0.058" (1.5 mm)	73LP	
1519-9004-64	64E	3/8"	0.058" (1.5 mm)	73LP	
1519-9004-68	68E	3/8"	0.058" (1.5 mm)	73LP	
1519-9004-72	72E	3/8"	0.058" (1.5 mm)	73LP	
4113742	66E	3/8"	0.058" (1.5 mm)	73DP	SP 680
4113740	68E	3/8"	0.058" (1.5 mm)	73DP	
4113741	72E	3/8"	0.058" (1.5 mm)	73DP	SP 680
4113760	60E	1/4"	0.050" (1.3 mm)	25AP	SPR 270C

FILAR - FILMALLAR - FILHANDTAG

Detaljnr.	Längd	Bredd
1519-0012-01	Fil (3-pack)	5/32" (Ø 4.0 mm), 3/8" mini
1519-0013-01	Fil (3-pack)	3/16" (Ø 4.8 mm), 0.325"
1519-0014-01	Fil (3-pack)	13/64" (Ø 5.2 mm), 3/8"
1519-0015-01	Filmall m. fil	5/32" (Ø 4.0 mm)
1519-0016-01	Filmall m. fil	3/16" (Ø 4.8 mm)
1519-0017-01	Filmall m. fil	7/32" (Ø 5.5 mm)
1519-0018-01	Filhandtag	

SKYDDSKLÄDER

Detaljnr.	Benämning	Storlek
1599-1922-11	Skogsjacka	S
1599-1922-21	Skogsjacka	M
1599-1922-31	Skogsjacka	L
1599-1922-41	Skogsjacka	XL
1599-1922-51	Skogsjacka	XXL

Slitstark och bekväm jacka med stor rörlighetsfrihet och klara färger.



Detaljnr.	Benämning	Storlek
1599-1920-11	Säkerhetsbyxor	46
1599-1920-21	Säkerhetsbyxor	48
1599-1920-31	Säkerhetsbyxor	50
1599-1920-41	Säkerhetsbyxor	52
1599-1920-51	Säkerhetsbyxor	54
1599-1920-61	Säkerhetsbyxor	56
1599-1920-71	Säkerhetsbyxor	58

Byxor vadderade med 9 lager med kevlar-fiber.

Skyddsinnlägg design A, klass 1, 20 m/s. Byxorna tillverkade av en blandning av polyester och bomull. Godkända enligt EN 381-5.



Detaljnr.	Benämning	Storlek
1599-1925-11	Säkerhetsbyxor	46
1599-1925-21	Säkerhetsbyxor	48
1599-1925-31	Säkerhetsbyxor	50
1599-1925-41	Säkerhetsbyxor	52
1599-1925-51	Säkerhetsbyxor	54
1599-1925-61	Säkerhetsbyxor	56
1599-1925-71	Säkerhetsbyxor	58

Byxor vadderade med 9 lager med kevlar-fiber.

Skyddsinnlägg design A, klass 1, 20 m/s. Byxorna tillverkade av en blandning av polyester och bomull. Godkända enligt EN 381-5.



SKYDDSKLÄDER

Detaljnr.	Benämning	Storlek
1599-1926-01	Stövlar	39
1599-1926-11	Stövlar	40
1599-1926-21	Stövlar	41
1599-1926-31	Stövlar	42
1599-1926-41	Stövlar	43
1599-1926-51	Stövlar	44
1599-1926-61	Stövlar	45
1599-1926-71	Stövlar	46
1599-1926-81	Stövlar	47

Stövlar med skyddsinnlägg på ovansidan och stålhätta.



Detaljnr.	Benämning	Anm.
1599-1912-11	Hjälpaket	One Storlek

Vikt 650 gram.



Detaljnr.	Benämning
1599-1918-21	Hörselskydd/radio
1599-1918-31	Hörselskydd/radio + telefon

Hörselskydden godkända enligt EN 352-1.



Detaljnr.	Benämning	Storlek
1599-1911-32	Säkerhetspaket	L
1599-1911-42	Säkerhetspaket	XL
1599-1911-52	Säkerhetspaket	XXL

Paket med skyddsbyxor, handskar, hjälm med visir och hörselskydd.

Hängselbyxa i en blandning av bomull och polyester. Skyddsinnlägg med 9 lager, design A, klass 1 (20 m/s). Godkända enligt EN 381-5.



SKÄRHUVUDEN - TRÅDSPOLAR



Pos	Detaljnr.	Benämning	Passar till
1	1911-9027-01	Trådspole	ST 350/350J
2	1911-9021-01	Trådspole	ST 500
3	1911-9025-01	Skärhuvud	ST 1200 (2002-)
4	1911-9024-01	Trådspole	ST 1200
5	6985095	Skärhuvud	ST 750, ST 900J
6	6985096	Skärhuvud	ESB 1000J
7	6980120	Skärhuvud	ST 210
8	6980300	Skärhuvud	SB 22
9	383820503/0	Skärhuvud	ST 27J (2008-)
9	383820504/0	Skärhuvud	SB 27J, SB 27JD (2008-), SB 32, SB 32D (2008-)
10	123155008/0	Skärhuvud	ST 26J
10	123155009/0	Skärhuvud	SB 26J; SB 34; SB 34D

SKÄRHUVUDEN



Pos	Detaljnr.	Benämning	Passar till	Anm.
1	4353240/1	Skärhuvud	SB 28/30/43P/52 PRO/29/35/435H/BJ 335/335D/BJ345D; SB 435H/HD; SB 29S/29 DS	M8-tapp, vä-gånga
1	23155000/0	Skärhuvud	SB 27J, SB 29J, SB 425, SB 426, SB 425H/HD, BJ 325/325D	M10-hål, hö-gånga
2	23155002/1	Skärhuvud	ST 1100	M8-tapp, vä-gånga
2	23155001/1	Skärhuvud	ST 290, ST 291, ST 425J/HJ ST 29S	M10-hål, hö-gånga
3	4353000	Skärhuvud	SB 35S/DS, SB 43S/DS/FS, SB 44P, SB 51S/DS/FS	M8-tapp, vä-gånga
4	6981223	Skärhuvud	SB 25J, SB 25D	
4	6981308	Skärhuvud	ST 225J	

SKÄRTRÅD



Pos	Detaljnr.	Benämning	Innehåller	Diam. (mm)
1	1911-9022-01	Skärtråd	15 m	1.0
	1911-9017-01	Skärtråd	15 m	1.4
	1911-9006-08	Skärtråd	15 m	1.6
	1911-9007-08	Skärtråd	15 m	2.0
	1911-9008-08	Skärtråd	15 m	2.4
	1911-9010-07	Skärtråd	10 m	3.0
2	1911-9017-02	Skärtråd	100 m	1.4
	1911-9006-04	Skärtråd	200 m	1.6
	1911-9007-04	Skärtråd	130 m	2.0
	1911-9008-04	Skärtråd	90 m	2.4
	1911-9010-04	Skärtråd	55 m	3.0

ÖVRIGT (TRIMMER, RÖJARE)

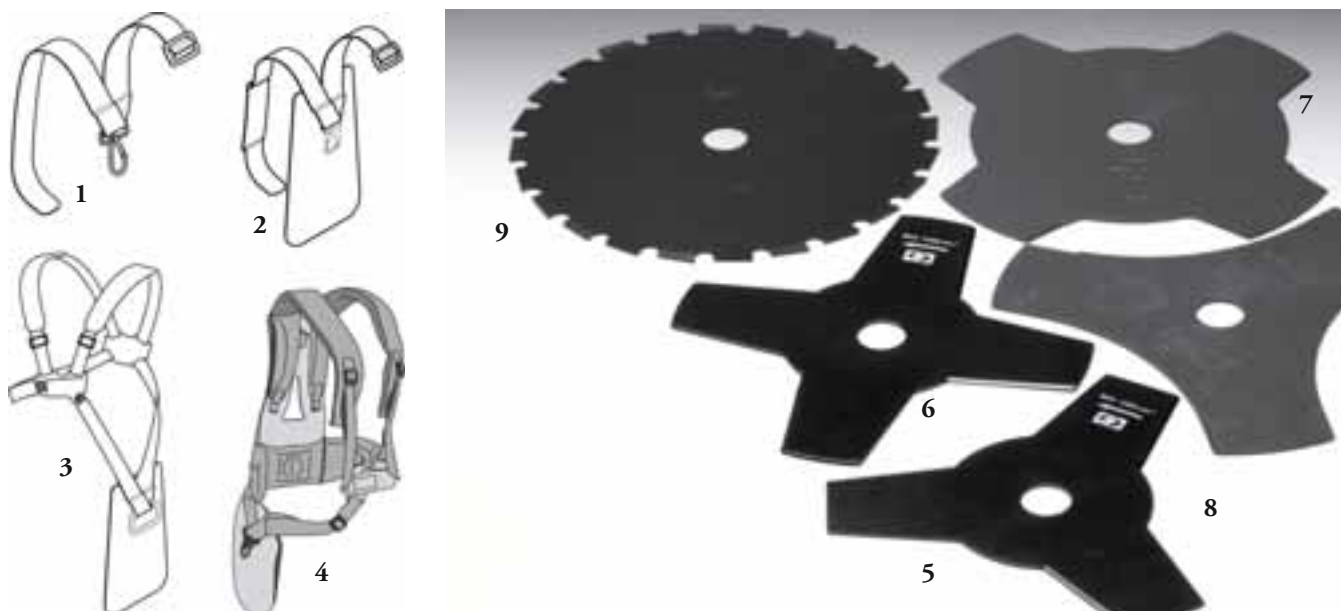

Pos	Detaljnr.	Benämning	Passar till	Anm. (mm)
1	4253420	Bärrem		
2	4253460	Bärrem m. höftskydd		
ej ill	4253440	Sele		
3	123046000/0	Sele		
4	123046002/0	Sele		
5	123155005/0	Röjklina (3T)	SB 27J, SB 27JD	Ø = 225 hål = 25,4
5	123155010/0	Röjklina (3T)	SB 26J; SB 26JD; SB 34; SB 34D	Ø = 225 hål = 25,4
6	123155006/0	Röjklina (4T)	SB 32, SB 32D	Ø = 230 hål = 25,4
7	4611880	Röjklina (4T)	SB 29/35/35S/35DS/43/43DS/51/51DS/425/435/435H/HD; BJ 335/335D/345D	Ø = 255 hål = 25,4
8	6031172	Röjklina (3T)	SB 29/29S/29DS/35/425/425H/425HD, BJ 325/325D	Ø = 255 hål = 25,4
9	6031185	Sågklina (24T)	SB43/43DS/44/51/51DS	Ø = 255 hål = 25,4

OLJA - FÄRG



Pos	Detaljnr.	Benämning	Passar till	Anm.
1	1111-9140-01	Motorolja	Mineral SAE 30	12 x 0.6 lit.
-	1111-9171-01	Motorolja	Delsyntet SAE 10W-30	12 x 0.6 lit.
-	1111-9151-01	Ställ med motorolja	Mineral SAE 30	189 x 0.6 lit.
2	1111-9141-01	Motorolja	Mineral SAE 30	9 x 1.4 lit.
-	1111-9144-01	Motorolja	Syntet SAE 5W-30	9 x 1.4 lit.
-	1111-9146-01	Motorolja	Delsyntet SAE 10W-30	9 x 1.4 lit.
3	1111-9147-01	Motorolja	Mineral SAE 20W-50	3 x 4.0 lit.
-	1111-9145-01	Transmissionsolja	Synthetic SAE 5W-50	3 x 4.0 lit.
4	1111-9149-01	Sågkedjeolja	Mineral	9 x 1.4 lit.
-	1111-9150-01	Sågkedjeolja	Mineral	3 x 4.0 lit.
5	1111-9160-01	2-taktsolja	Delsyntet	25 x 0.1 lit.
-	1111-9148-01	2-taktsolja	Delsyntet	12 x 0.6 lit.
6	1111-9176-01	2-taktsolja	Syntet-dozer	12 x 1 lit.
7	1111-9177-01	2-taktsolja	Syntet	24 x 1 lit.
8	9498-0311-01	Färg	STIGA-gul	0.25 lit.
8	9498-0311-02	Färg	STIGA-grå	0.25 lit.

OLJEBYTE - BRÄNSLE



Pos	Detaljnr.	Benämning	Anm.
1	1134-3898-01	Oljepump	Ingår i 1134-4452-01
2	1134-4452-01	Oljebytarsats	
3	1111-9118-01	Oljepluggsnyckel	3/8"
4	9500-9934-01	Bensindunk-plast	Rymd: 5 lit.
5	1111-9162-01	Etanol E85	Innehåller etanoladditiv som motverkar oxid.
6	131240011/0	Etanoltillsats	MTR-LIFE, 10 x 4 cc

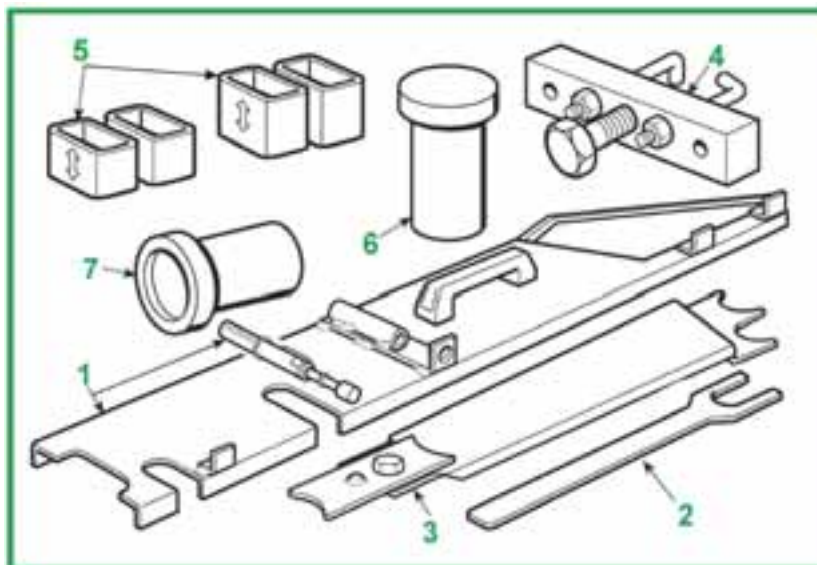



Pos	Detaljnr.	Benämning
1	382180081/0	Verktyg för kontroll av remspänning vid knivkoppling
2	382180080/0	Demonteringsverktyg för koppling
3	382180079/0	Distansmall, centrering remskiva
4	382180078/0	Pulley Avdragare, remskiva
5	382180077/0	Block H= 26 mm för aggregatjustering Block H= 32 mm för aggregatjustering
6	382180076/0	Bussning för montering av knivlager
7	382180075/0	Plugg för montering av hjullager

För olika arbeten som montering, demontering, kontroll och justeringar, rekommenderar vi användandet av de specialverktyg som verktygsådan (väskan) innehåller. Rekommendationer för korrekt användning av dessa verktyg finns i vår Workshop manual.



Pos	Detaljnr.	Användarguide	Åkgräsklippare
1	382180081/0		102/122

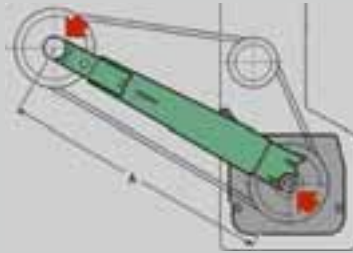

Pos	Detaljnr.	Användarguide	Åkgräsklippare
2	382180080/0		63

SERVICESATS

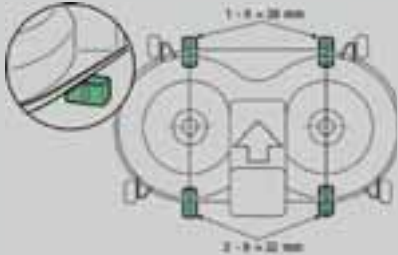
Pos	Detaljnr.	Användarguide	Åkgräsklippare
3	382180079/0	 	102/122

Pos	Detaljnr.	Användarguide	Åkgräsklippare
4	382180078/0	 	102/122 98 92 72

Pos	Detaljnr.	Användarguide	Åkgräsklippare
5	382180077/0	 	102/122 98 92 72 63

Pos	Detaljnr.	Användarguide	Åkgräsklippare
6	382180076/0	 	102/122 98 92 72

SERVICESATS

Pos	Detaljnr.	Användarguide	Åkgräsklippare
7	382180075/0	 	102/122 98 92 72 63

T BOX



Detaljnr.	Benämning
381009920/0	Kit tester T-Box

Testkit, T-Box Rel.0/200/, består av hårdvara (enhet och interfacekablar för anslutning till korten) och en självinstallerande mjukvara, kompatibel med de mest använda operativsystemen från Microsoft. (I den bifogade guiden som medföljer testkitet redogörs för de olika systemkraven för användandet av mjukvaran)

SPECIALSKRUVMEJSLAR



1

2

Specialskruvmejslar för förgasarinställning.

Pos	Detaljnr.	Passar till
1	23049000/0	SP382, SP 402-422-442, SP 472, SP 350, SP 400, SP 380, SP 482, SP 522
2	123049003/0	BT 325- BJ 335 - BJ 345 (Mono-Duplex - Flex) - TR 26 - TB 26 - TB 34 (Mono - Duplex) - BL 250 H

HH SPECIAL VERKTYGSSATS



Detaljnr.	Benämning
381009930/0	HH special verktygssats

För olika arbeten som montering, demontering, kontroll och justeringar, rekommenderar vi användandet av de specialverktyg som verktygslådan (väskan) innehåller. Rekommendationer för korrekt användning av dessa verktyg finns inuti väskan.

HH SPECIAL VERKTYGSSATS

STANS

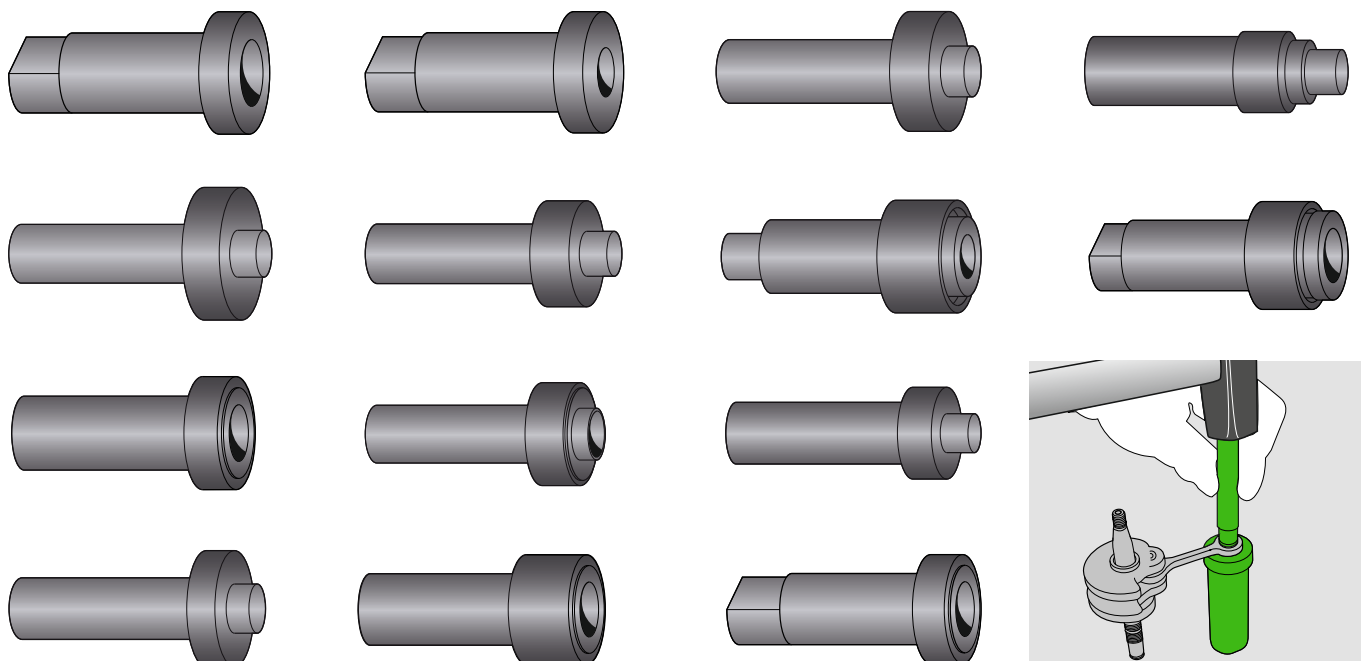

AVDRAGARE

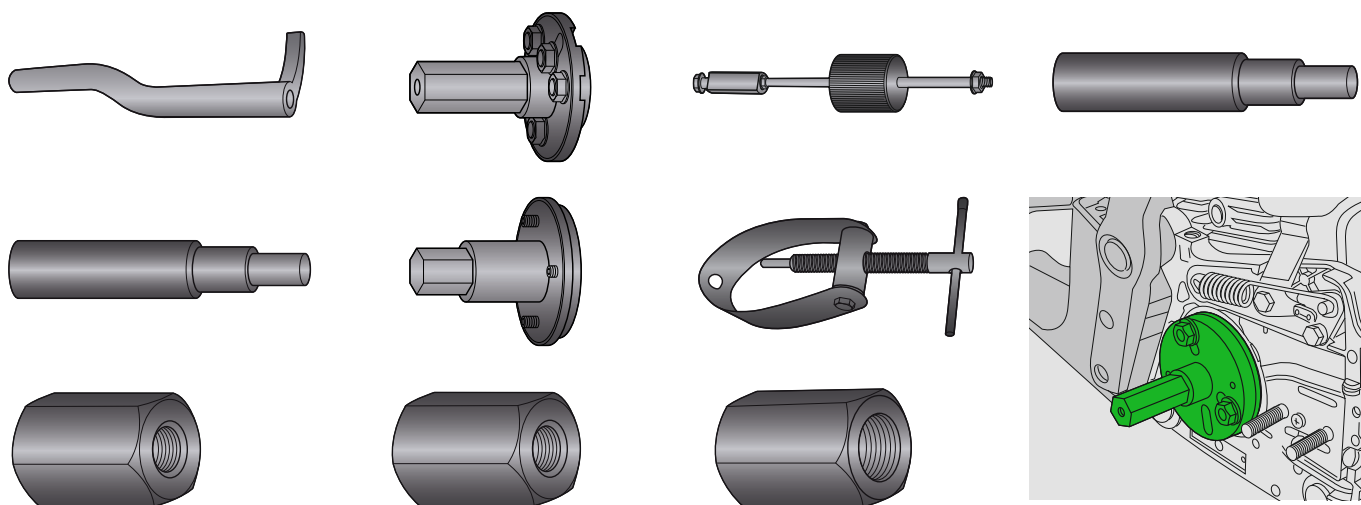

KOLVBLOCKERINGSVERKTYG

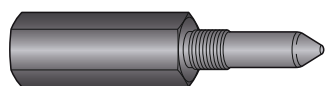

DIVERSE

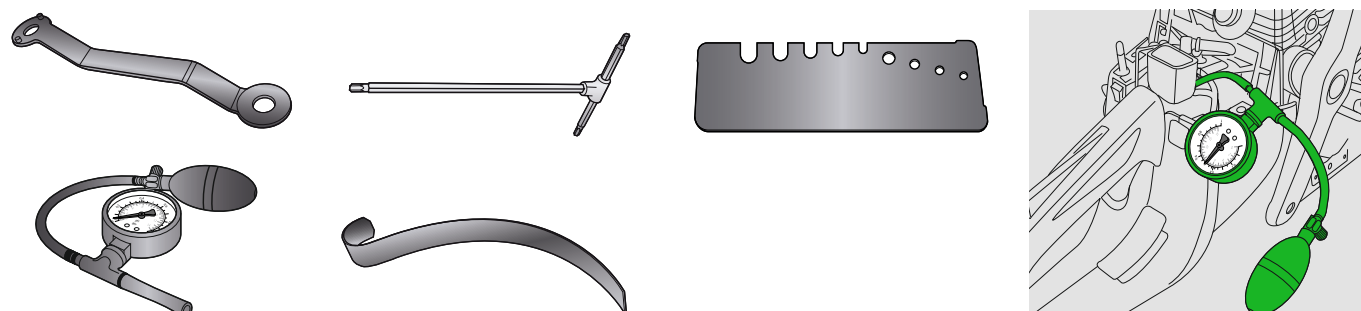



www.stiga.se

**GGP GROUP
GLOBAL GARDEN PRODUCTS**

Via del Lavoro, 6
31033 Castelfranco Veneto (Treviso) - ITALY
Tel. +39.0423.450111
Fax +39.0423.450670
www.ggp-group.com
infoline@ggp-group.com



Your Stiga stockist



Uppgifter, avseende egenskaper och tekniska specifikationer, som lämnas i denna broschyr, kan ändras fortlöpande.

Anm. Information som ges under "Passar till" är på grund av utrymmesskäl begränsad. För utförligare information, se <http://spareparts.ggp-group.com>.